



TABLE OF CONTENTS

PRODUCT OVERVIEW

Unit Features	3
Entry System Codes: Square-Top	5
Entry System Codes: Arch- And Radius-Top	6
Handing Configurations	7
Minimum and Maximum Guidelines	8
Measurement Conversions	9
Net Clear Opening	10
Overhang Requirement For Warranty Coverage	11

PRODUCT DETAILS

Section Details – Frame Options	12
Section Details – Operating – Single – 1- $\frac{3}{4}$ " Door	13
Section Details – Operating – Pair – 1- $\frac{3}{4}$ " Doors	14
Section Details – Operating – Single – 2- $\frac{1}{4}$ " Door	15
Section Details – Operating – Pair – 2- $\frac{1}{4}$ " Doors	16
Section Details – Dingle, Pair, Sidelite – 1- $\frac{3}{4}$ " Door	17
Section Details – Single, Pair, Sidelite – 2- $\frac{1}{4}$ " Door	18
Section Details – In-Sash Transom	19
Section Details – Direct Set Transom	20
Section Details – Vertical Mulling Options	21
Section Details – Horizontal Mulling Options	22
Sticking Options – 1- $\frac{3}{4}$ " Door	23
Sticking Options – 2- $\frac{1}{4}$ " Door	24
Panel Options – 1- $\frac{3}{4}$ " Door	25
Panel Options – 2- $\frac{1}{4}$ " Door	26
Simulated Divided Lites (SDL) Options – 1- $\frac{3}{4}$ " Door	27
Simulated Divided Lites (SDL) Options – 2- $\frac{1}{4}$ " Door	29
True Divided Lites (TDL) Options – 1- $\frac{3}{4}$ " Door	31
True Divided Lites (TDL) Options – 2- $\frac{1}{4}$ " Door	33
Exterior Applied Moulding Options – 1- $\frac{3}{4}$ " Door	35
Exterior Applied Moulding Options – 2- $\frac{1}{4}$ " Door	36

PRODUCT ACCESSORIES

Sill Options – Oak Adjustable	37
Sill Options – Solid Wood	38
Sill Options – ADA	39
Sill Options – Hydrosill™	40
Sill Options – Solid Wood and Bronze Interlock	41
Wood Swinging Screen Options	42
Accessories	43

Unit Features

Maximum Sizes:

Pre-hung doors:

- Maximum: 42" wide × 96" high

Slab doors:

- Maximum: 48" wide × 120" high

Sidelites:

- Maximum: 36" wide × 120" high

Transoms:

- Maximum: 120" wide × 48" high

Overall Entry System:

Factory assembled maximum: 93" wide × 96" high

Certified units: Rules TBD

System layouts: See page 4 to choose from available configurations

Available Frame Types:

Uniframe:

- Minimum: 4-⁹/₁₆"
- Maximum: 6-⁹/₁₆"

Single Rabbet:

- Minimum: 4-⁹/₁₆"
- Maximum: 9"

Double Rabbet:

- Minimum: 4-⁹/₁₆"
- Maximum: 9"
- With screen door minimum: 6-⁹/₁₆" – maximum: 9"

Frame Mulling Options:

Prep for field mull

Factory mull

Spread mull:

- Minimum: 1"
- Maximum: 6"

Reinforced mull:

- Minimum: 1" LVL,
- Maximum: 2" LVL

Sill Options:

Available as continuous up to 120"

Available with sill horns:

Depth

- Minimum: 1-¹/₁₆"
- Maximum: 3-⁷/₁₆"

Length

- Minimum: 1"
- Maximum: 6"

Oak adjustable

Hydrosill

- Sill horns not available for Hydrosill™.

ADA sill

Solid honduran mahogany

Solid plain sawn white oak

Solid honduran mahogany with bronze interlock

Solid plain sawn white oak with bronze interlock

Sidelite Options:

600+ Door styles can be configured as sidelites

Available in-sash or direct set

Transom Options:

Choose from 23 glass or panel transom options

Available in-sash or direct set

Note: all transoms ship separately for field mulling

Natural Wood Species:

Standard ¹/₁₆" flitch veneers

Optional ¹/₈" veneers

- Stain-grade genuine mahogany
- Stain-grade mahogany
- Paint-grade mahogany
- Douglas fir
- Cherry
- White oak
- Walnut
- Paint-grade douglas fir
- Alder

Sticking Profiles

Styles (see pages 22-23)

- OG – Roman Ogee
- SS – Square Stick
- QB – Quarter Bead
- QR – Quarter Round
- CB – Cove and Bead
- BV – Bevel
- OS – One Step
- LP – Low Profile Bolection Moulding
- CV – Cove Moulding
- BBM – Big Bolection Moulding
- BM – Bolection Moulding

Custom profiles available upon request

Panel Profiles:

Styles (see pages 24-25)

- A – Raised
- B – Scoop
- C – Flat
- D – Double Hip
- E – Senior Raised
- F – Senior Bevel

Custom profiles with size limitations — contact your Sales Rep for more information

Unit Features

Glass Types

Standard insulated glass:

- LoE 272 w/Argon (default)
- LoE 366
- LoE 340 (ELR)
- LoE 180
- White Lami
- Clear Lami
- Satin Etched
- Low Iron
- Frosted
- English Reeded
- Glue Chip
- Rain
- Obscure
- Aqualite
- Seedy Wash
- Bevel

Simulated Divided Lite (SDL) Options

Available in 5/8", 7/8", and 1-1/8" wide bars

- OG – Roman Ogee
- SS – Square Stick
- QB – Quarter Bead
- QR – Quarter Round
- CB – Cove and Bead
- BV – Bevel
- OS – One Step

True Divided Lite (TDL) Options

Only offered in 1-5/8" wide bars

- OG – Roman Ogee
- SS – Square Stick
- QB – Quarter Bead
- QR – Quarter Round
- CB – Cove and Bead
- BV – Bevel
- OS – One Step

Factory Finishing

Stain-grade: High-quality, exterior-grade factory finishing available. See <https://www.trustile.com/finishing-options/factory-finishing> for finish options by species

Paint-grade: High-quality, exterior-grade primer standard.

Hardware

Handle sets not provided

- Ability to machine for any cylindrical or mortise handle set

GU Security Automatic Multipoint available upon request

GU Security Rhino Multipoint lock available upon request

Note: multipoint locks are highly recommended on pair units and doors over 8' tall.

Hinges

4" × 4" ball bearing, square corner TruStile branded architectural hinges standard

Colors:

- US19 Flat Black
- US3 Bright Brass
- US4 Satin Brass
- US5 Antique Brass
- US10A Antique Bronze
- US10B Oil-Rubbed Bronze
- US14 Polished Nickel
- US15 Satin Nickel
- US15A Antique Nickel
- US26 Polished Chrome
- US26D Satin Chrome

Emtek and Baldwin hinges available upon request

Screen Door / Storm Door

Manufactured to match/complement the entry system

Screen options:

- Fiberglass
- Aluminum
- Bronze
- Hi-vis
- Pet

Options:

- Black hydraulic closer (default)
- Screen door handle sets from Emtek and Deltana available as standard options.

Casing options

WM180 – Brick Mould:

1-1/4" thick × 2" wide

Configurable S4S:

Available in all species in both 3/4" and 1" thicknesses

Entry System Codes – Square-Top

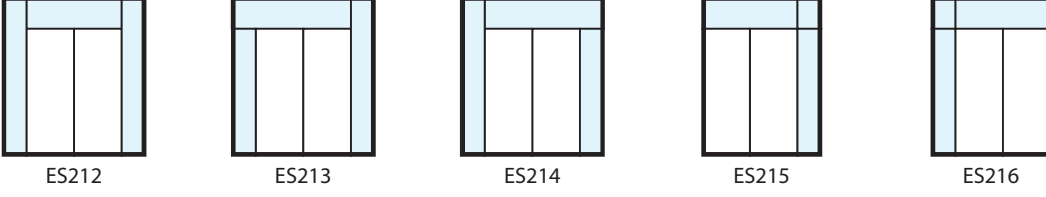
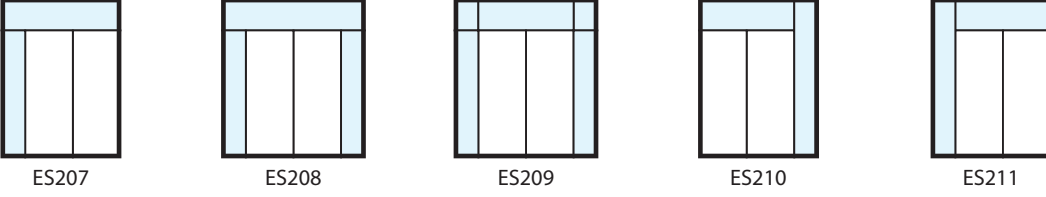
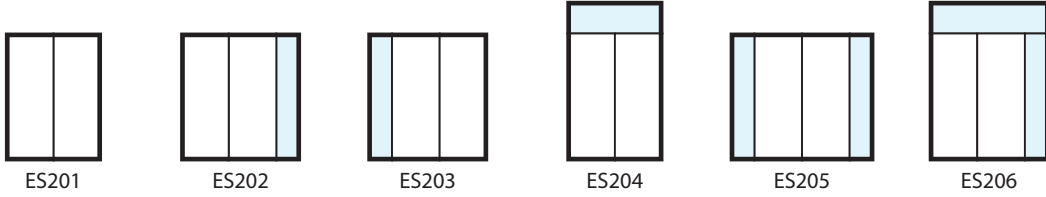
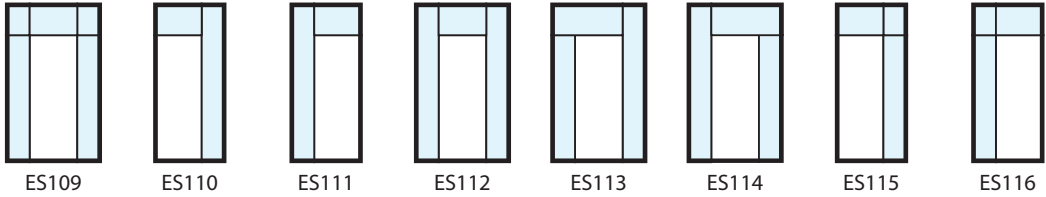
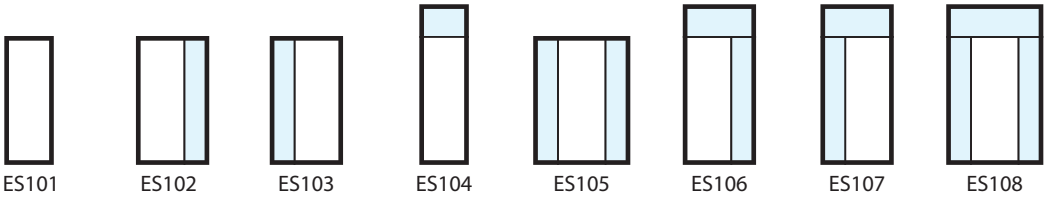

Entry System Codes: Arch- and Radius-Top



ES301



ES304



ES306

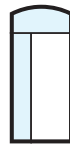

ES307

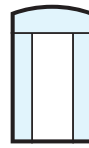

ES308



ES401



ES404



ES406

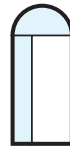

ES407

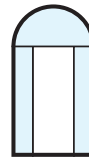

ES408



ES501

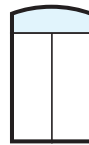

ES504

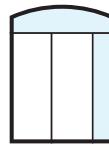

ES506

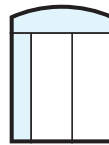

ES507

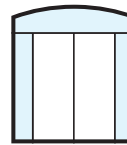

ES508



ES601

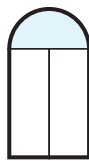

ES604

Handing Configurations

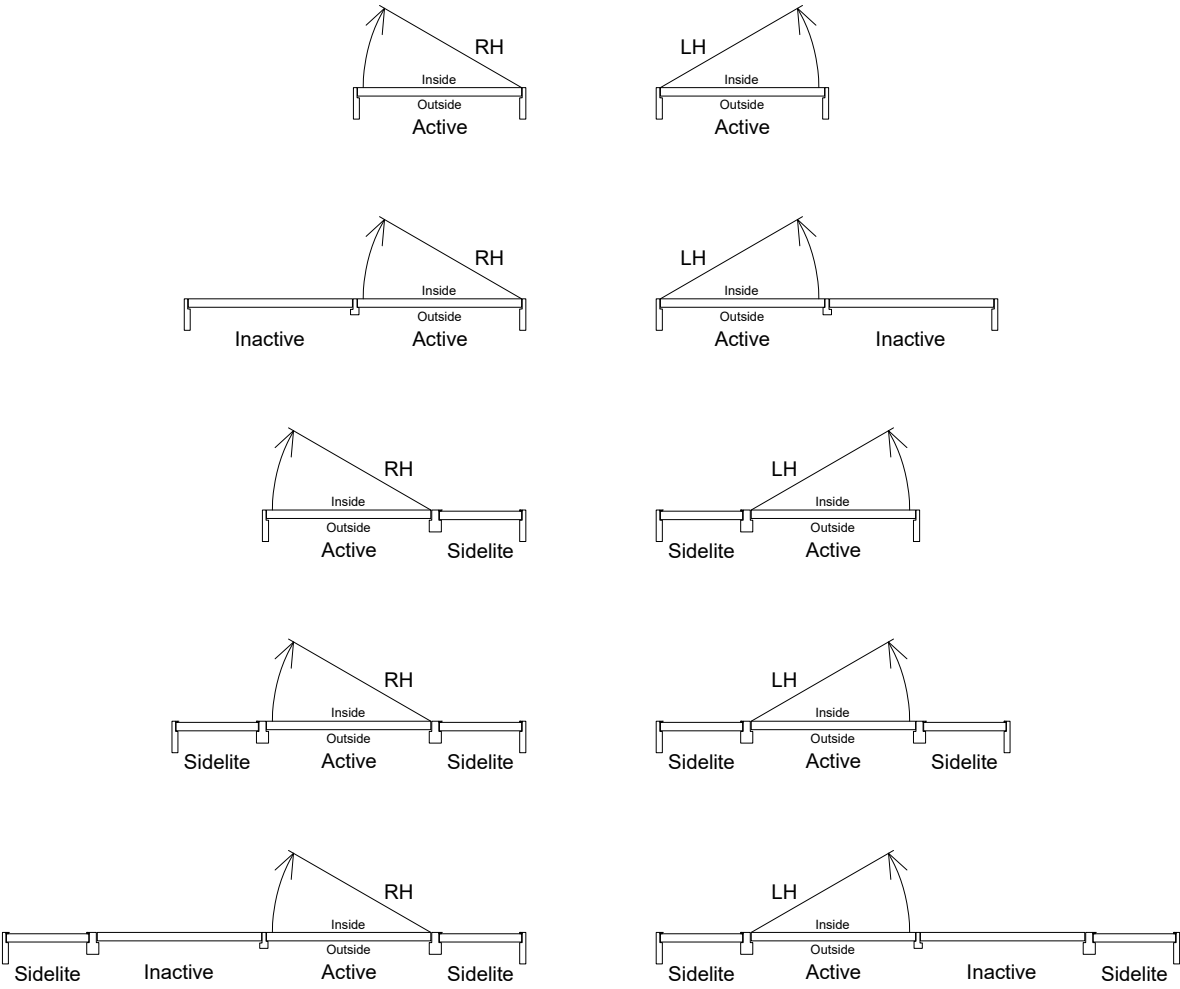

Minimum and Maximum Guidelines

1-3/4" Slab – Rectangle

Minimum and Maximum Slab Sizes								
Configuration	Minimum				Maximum			
	Width		Height		Width		Height	
	in	mm	in	mm	in	mm	in	mm
Unit Type								
1 3/4 Door	20	(508)	48	(1219)	36	(914)	96	(2438)
2 1/4 Door	20	(508)	48	(1219)	42	(1067)	120	(3048)
Pre-Hung Door	20	(508)	48	(1219)	42	(1067)	96	(2438)
Transom	20	(508)	10	(254)	96	(2438)	48	(1219)
Sidelite	10	(254)	48	(1219)	48	(1219)	120	(3048)
Sidelite Transom	10	(254)	10	(254)	48	(1219)	48	(1219)
Screen Door	20	(508)	48	(1219)	42	(1067)	120	(3048)
Direct Set Sidelite	10	(102)	48	(1219)	36	(914)	120	(3048)
Direct Set Transom	20	(508)	10	(254)	96	(2438)	48	(1219)
Direct Set Sidelite Transom	10	(102)	48	(1219)	48	(1219)	120	(3048)

*minimum width reflects unequal panel sizes with 18.000" operator panel width

*maximum width for the stationary panel of 124.010" for an 82.000" frame height

Measurement Conversions

Configuration	Unit Measurements		Width	
	From	To		
All	Rough Opening		in	mm
	Frame OM	Rough Opening	+ 1	(25)
	Masonry Opening	Rough Opening	+ 1/2	(13)

	Unit Measurements		Width	
	From	To		
Single	Slab		in	mm
	Panel Opening 2.25	Net Clear Opening	-3 33/64	(89)
	Panel Opening 1.75	Net Clear Opening	-3 1/64	(77)

	Unit Measurements		Width	
	From	To		
Pair	Slab		in	mm
	Panel Opening 2.25	Net Clear Opening	-5 5/64	(129)
	Panel Opening 1.75	Net Clear Opening	-4 37/64	(116)

Unit Measurements		Height	
From	To		
Rough Opening		in	mm
Frame OM	Rough Opening	+ 1/2	(13)
Masonry Opening	Rough Opening	+ 1/4	(06)
Net Clear Opening		in	mm
Frame OM Oak Adjustable	NCO	-2 5/8	(67)
Frame OM Wood	NCO	-2 5/8	(67)
Frame OM Hydrosill	NCO	-2 7/8	(73)
Frame OM ADA	NCO	-1 3/4	(44)
Frame OM Interlock	NCO	-3 11/32	(85)

Net Clear Opening

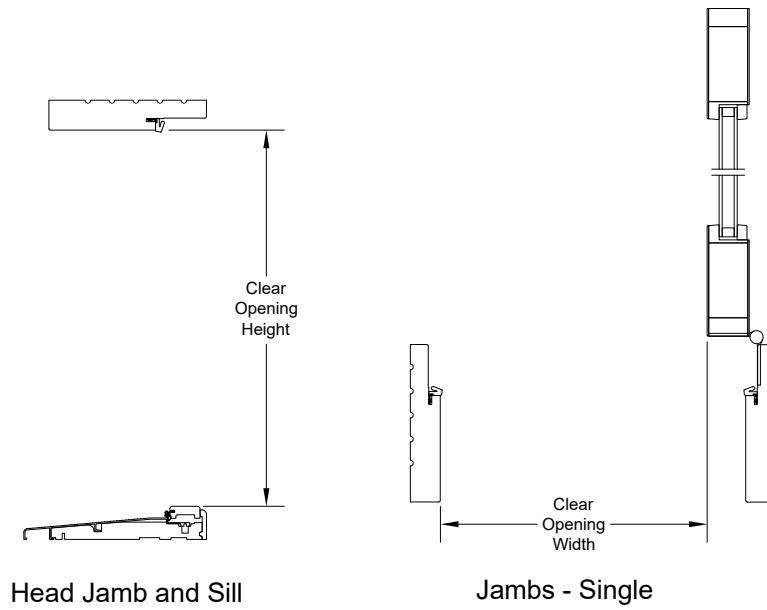

Head Jamb and Sill

Jambs - Single

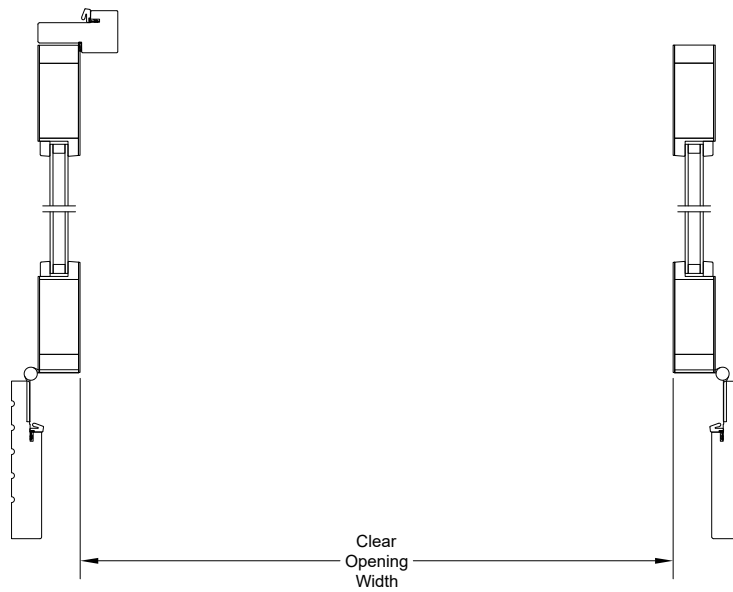

Jambs - Pair

Egress Code

International Building Code - 2012, 2015, and 2018

Section 1029 in 2012 code, Section 1030 in 2015 and 2018 code -
Emergency Escape and Rescue Openings

Minimum Size: Emergency escape and rescue openings shall have a
minimum net clear opening of 5.7 square feet (.053 m²).

Exception: The minimum net clear opening for grade-floor emergency
escape and rescue openings shall be 5.0 square feet (0.46m²).

Minimum Dimensions: The minimum net clear opening height
dimension shall be 24 inches (610). The minimum net clear opening
width dimension shall be 20 inches (508). The net clear opening
dimensions shall be the result of normal operation of the opening.

Maximum Height from Floor: Emergency escape and rescue openings
shall have the bottom of the clear opening not greater than 44 inches
(118) measured from the floor.

Operational Constraints: Emergency escape and rescue openings
shall be operational from the inside of the room without the use of
keys or tools. The 2018 code added the following sentence - window-
opening control devices complying with ASTM F2090 shall be permit-
ted for use on windows serving as a required emergency escape and
rescue opening.

Code restrictions may vary depending on your local building code.

Overhang Requirement for Warranty Coverage

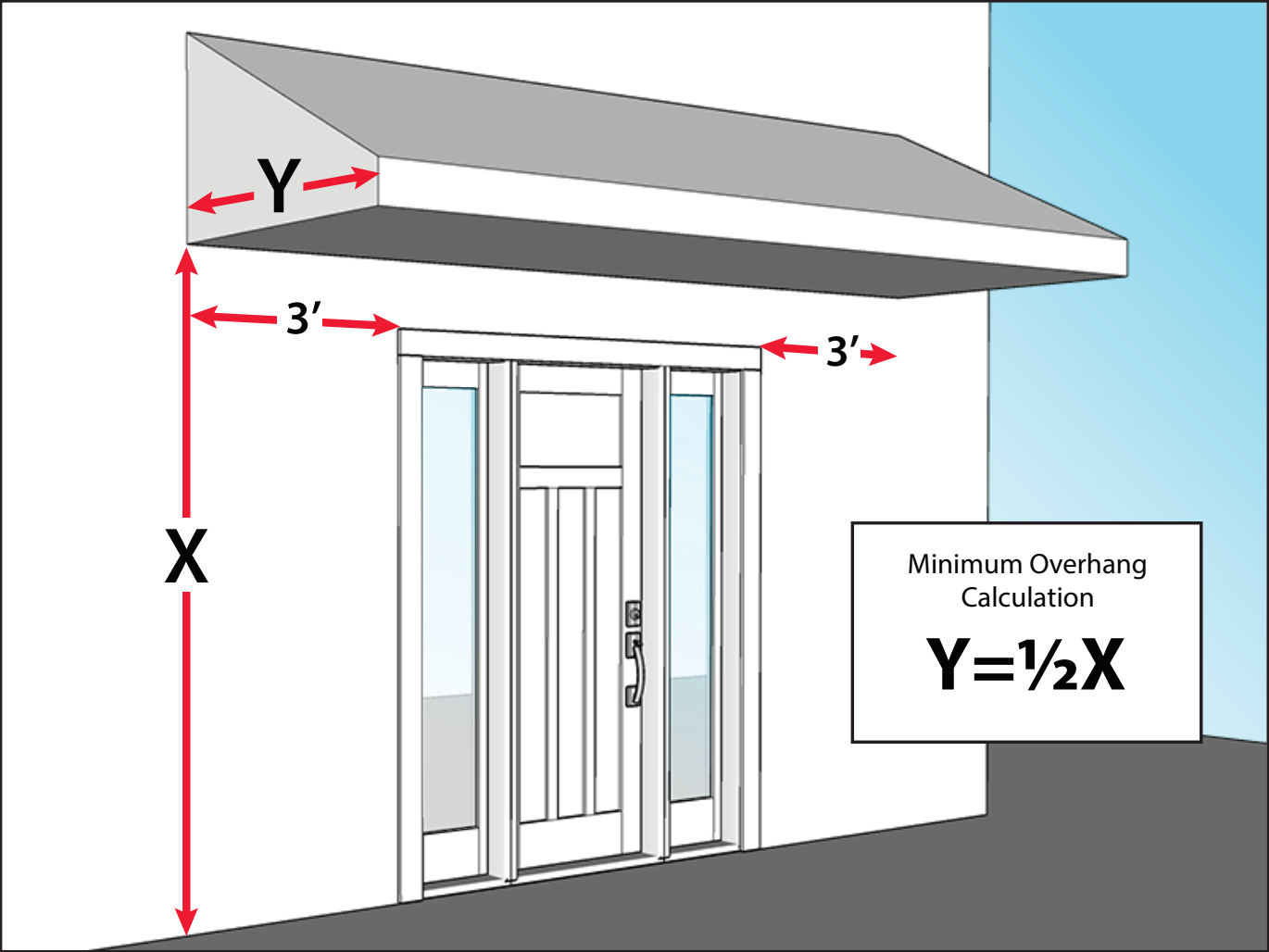

Section Details – Frame Options

Frame

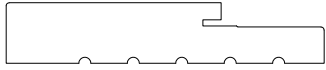

Square Edge Frame - Single Rabbeted



Square Edge Frame - Double Rabbeted

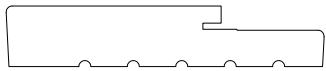

Radius Edge Frame - Single Rabbeted



Radius Edge Frame - Double Rabbeted

Uni-Frame Mull Post

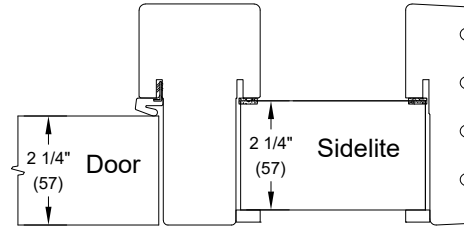
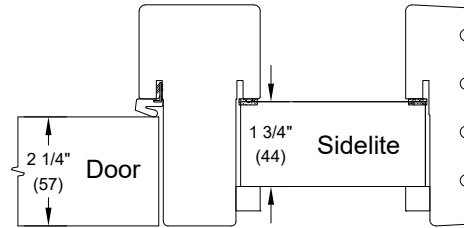
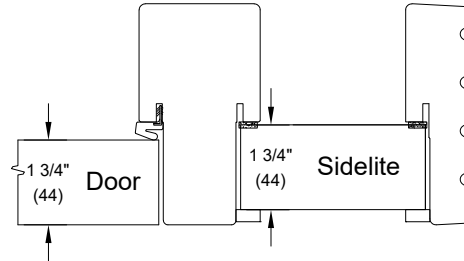

Back to Back Mull Post

Single Rabbet

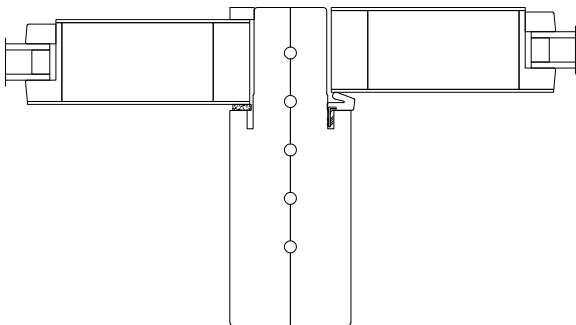

Double Rabbet

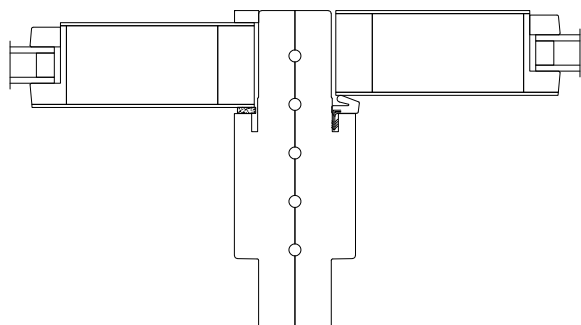

Section Details – Operating – Single 1-3/4" Door

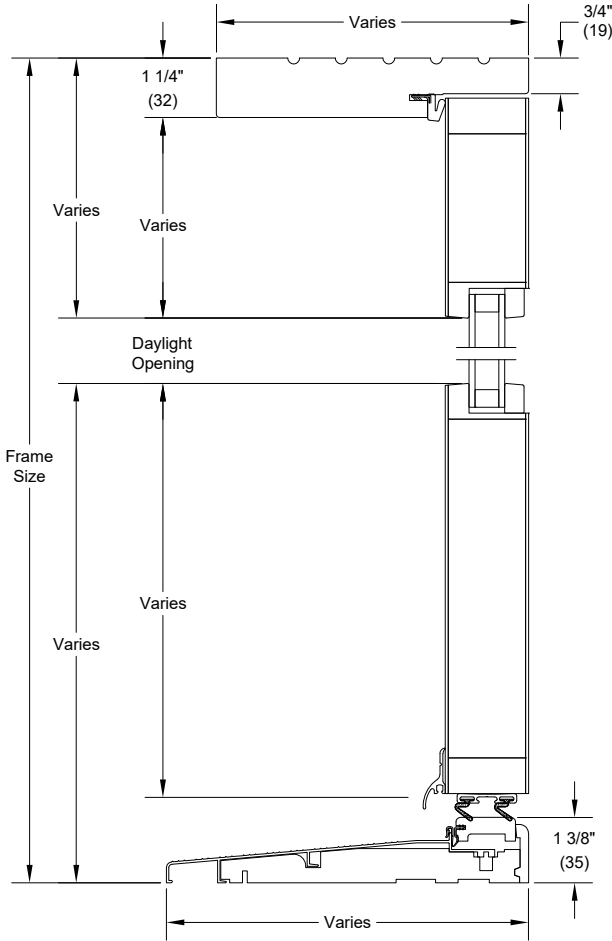

Head Jamb and Sill

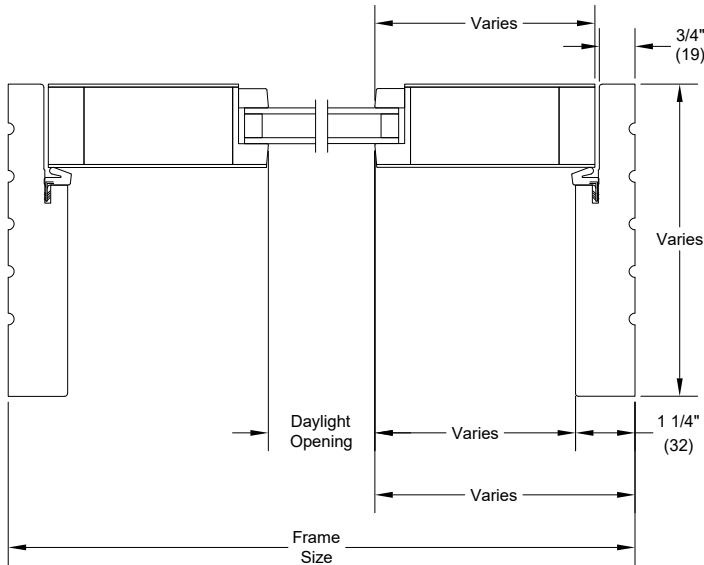

Jambs - Single

Section Details – Operating – Pair 1-3/4" Door

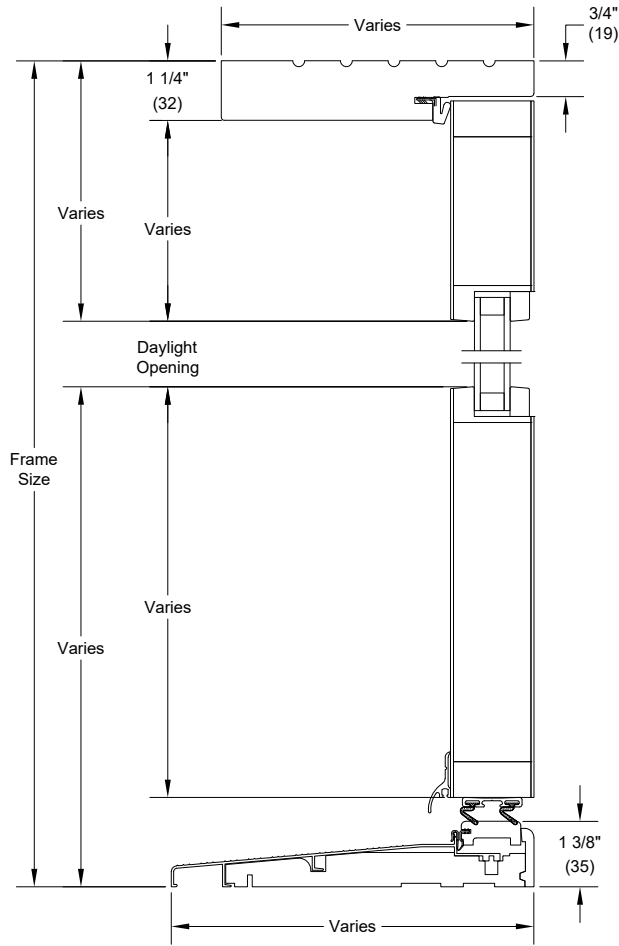

Head Jamb and Sill

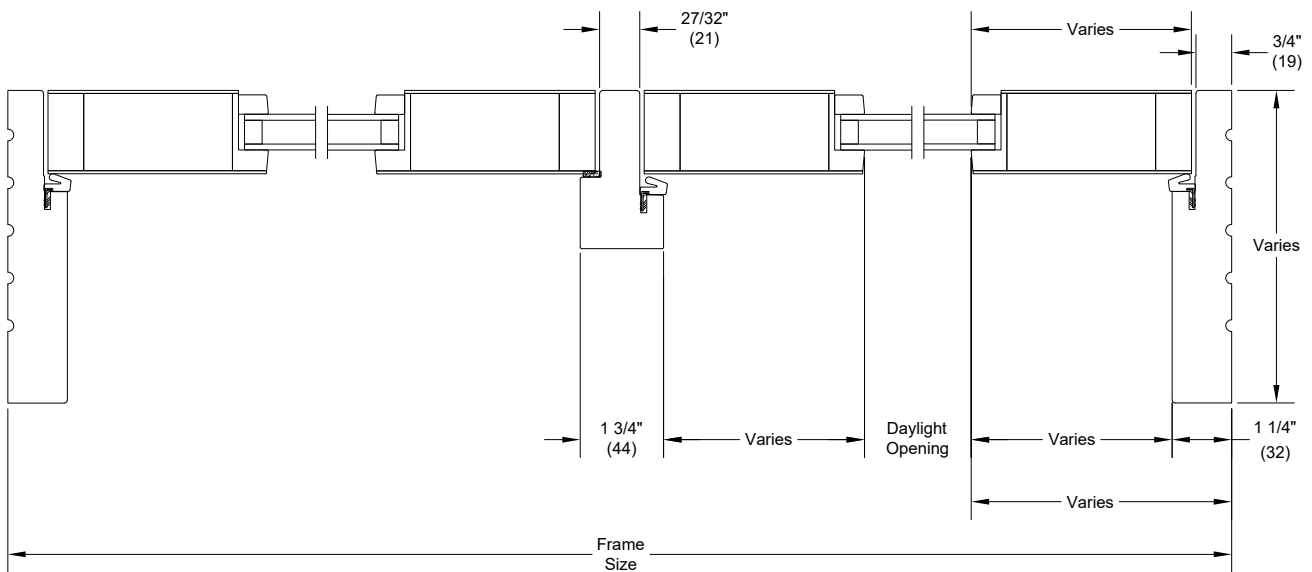

Jambs - Pair

Section Details – Operating – Single 2-1/4" Door

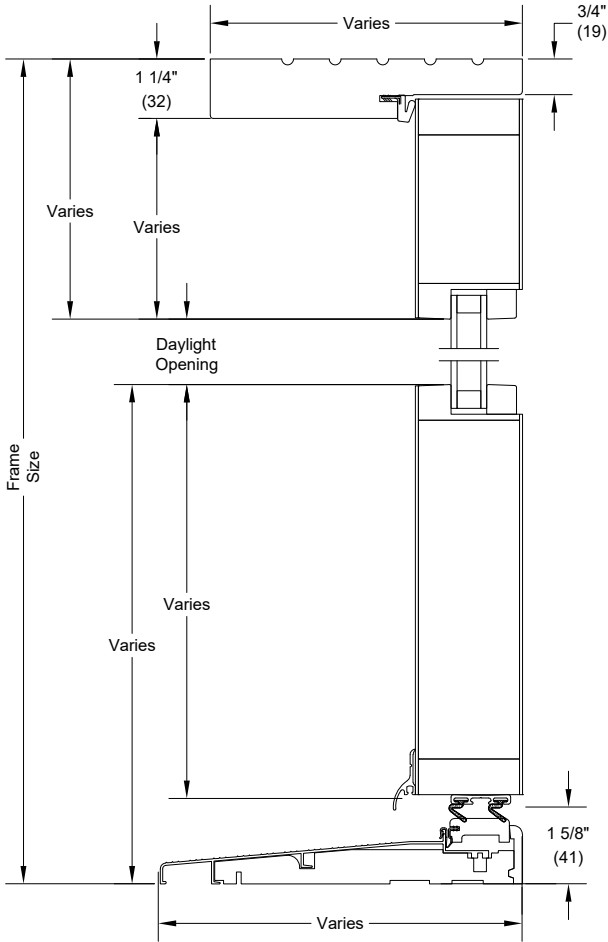

Head Jamb and Sill

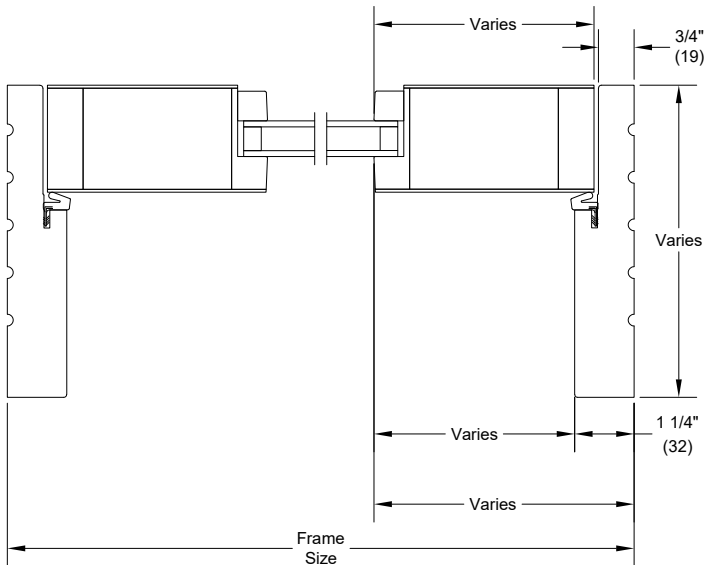

Jambs - Single

Section Details – Operating – Pair 2-1/4" Door

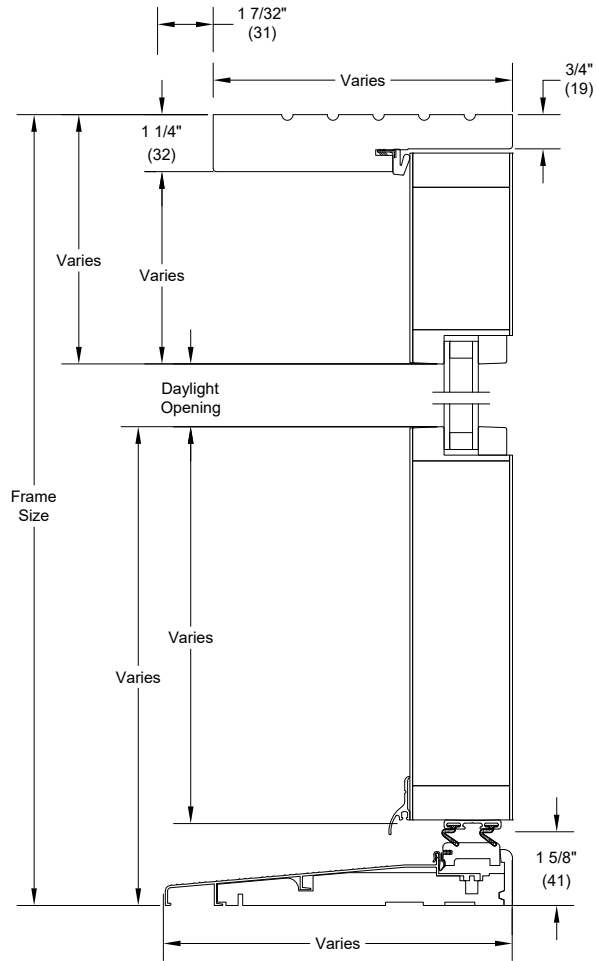

Head Jamb and Sill

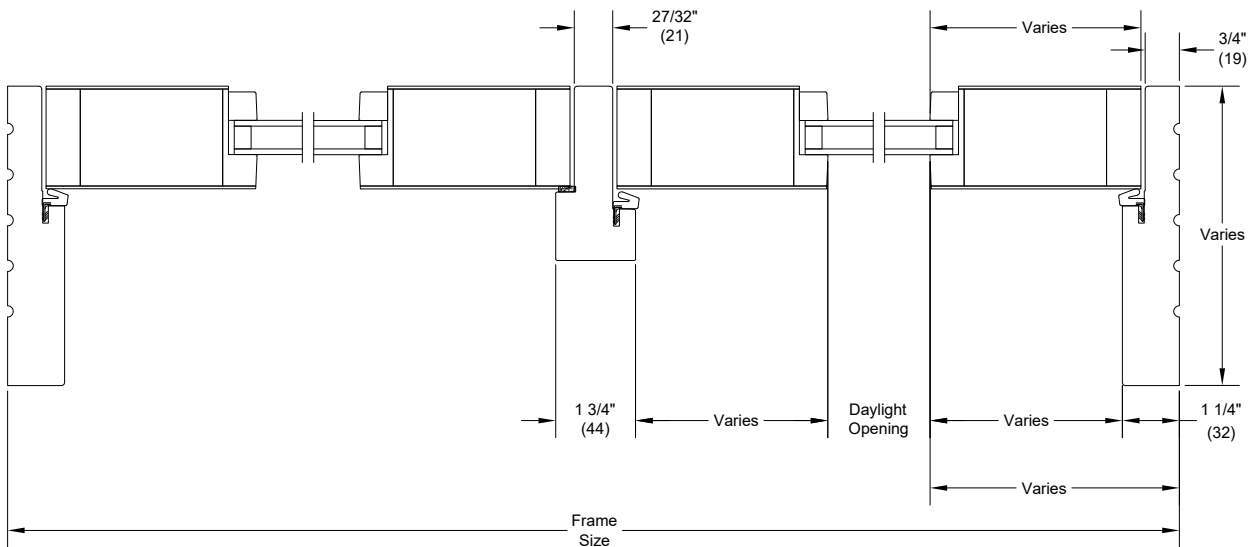

Jambs - Pair

Section Details – Single, Pair, Sidelite – 1-3/4" Door

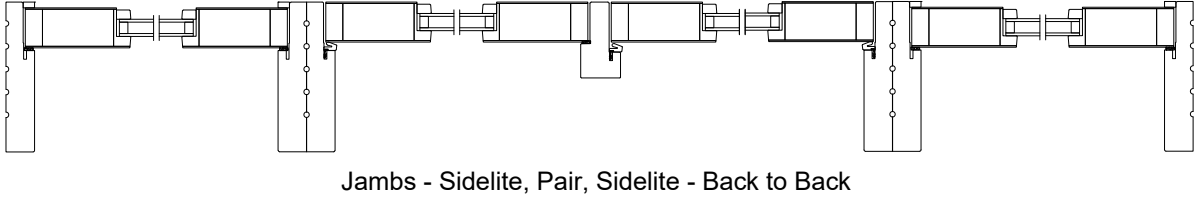
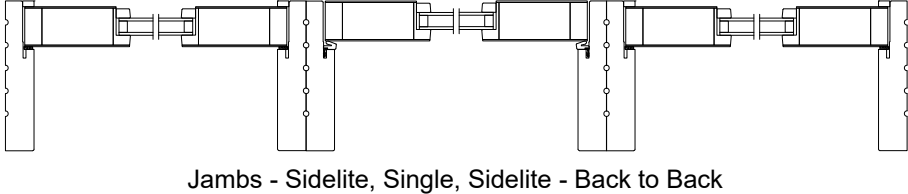
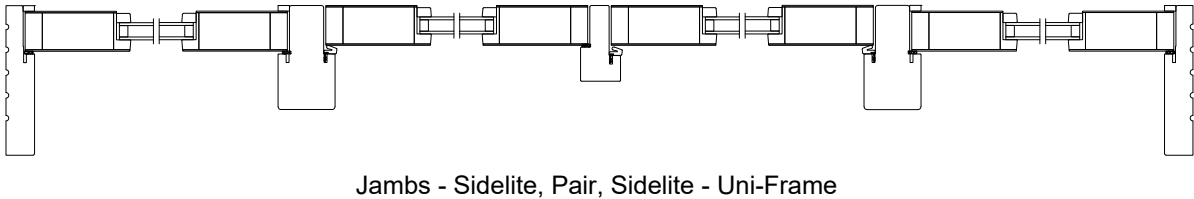
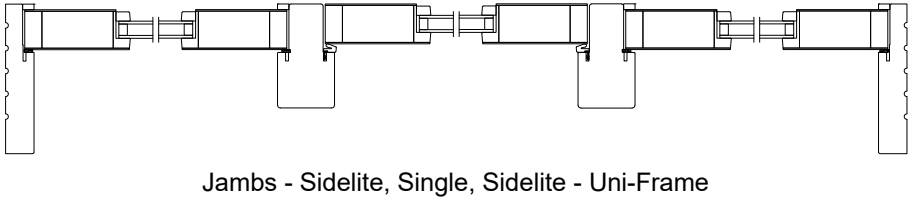
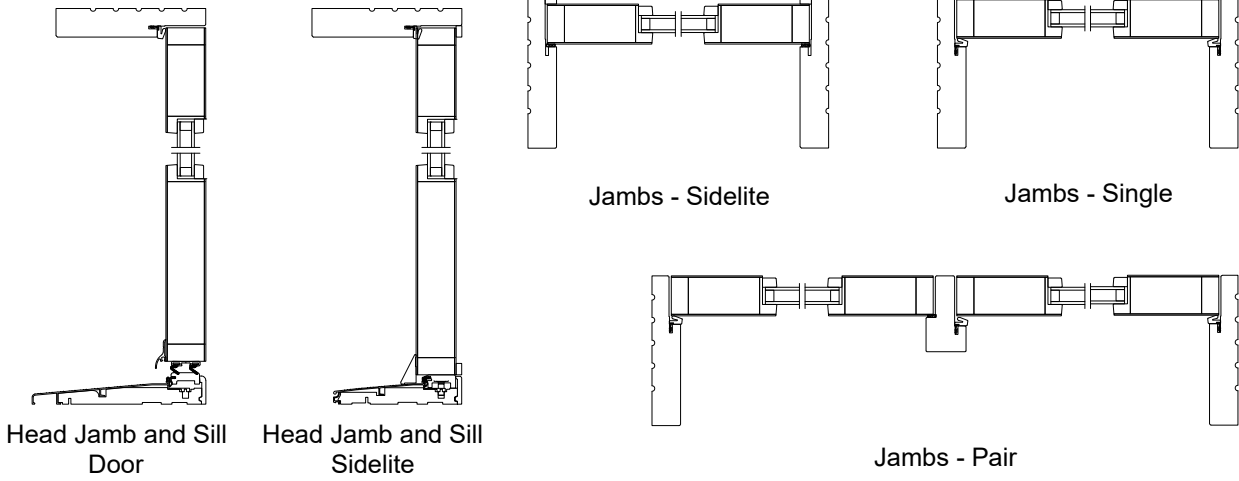

Section Details – Single, Pair, Sidelite – 2-1/4" Door

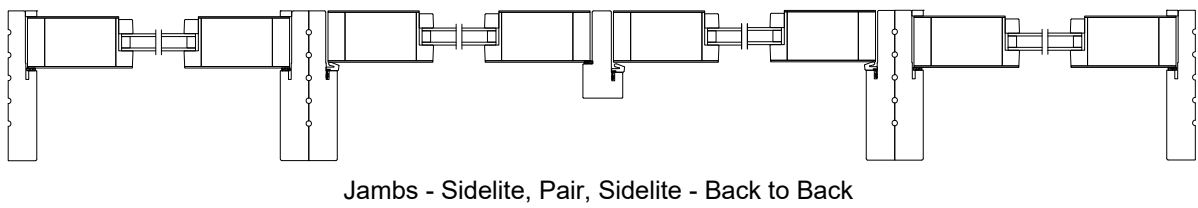
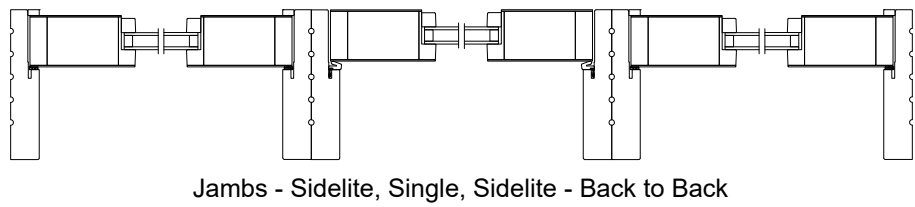
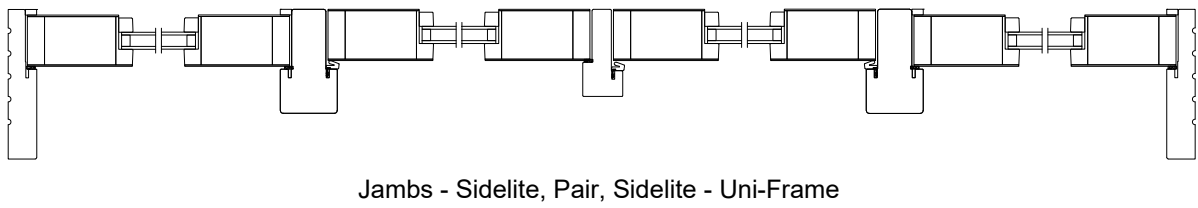
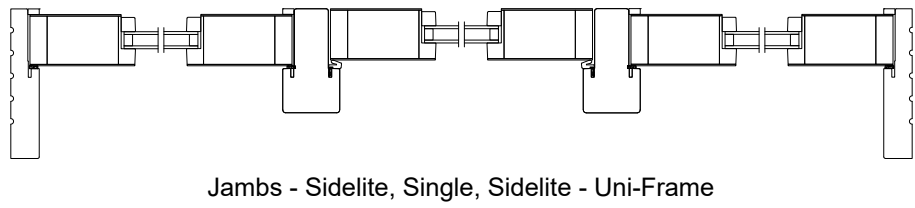
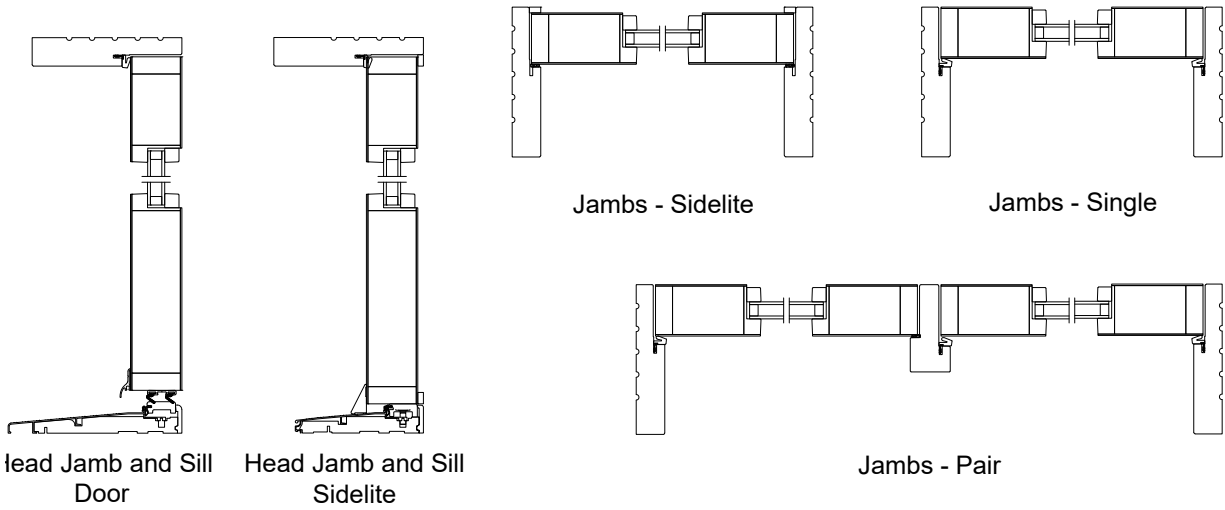

Section Details – In-Sash Transom

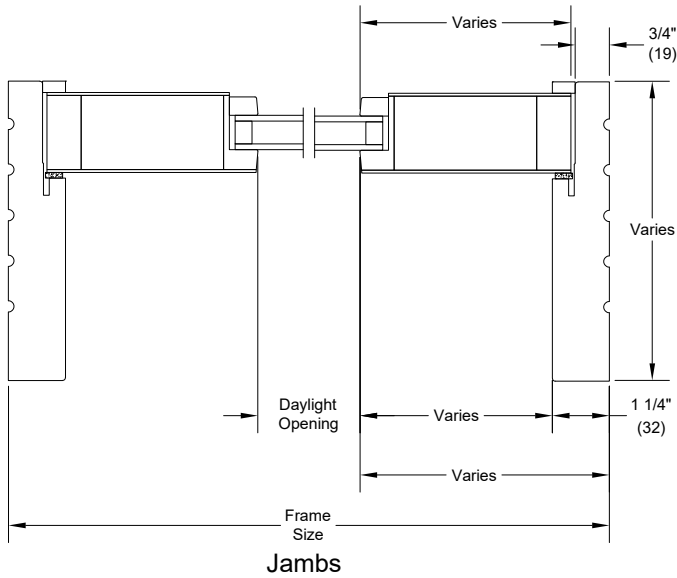
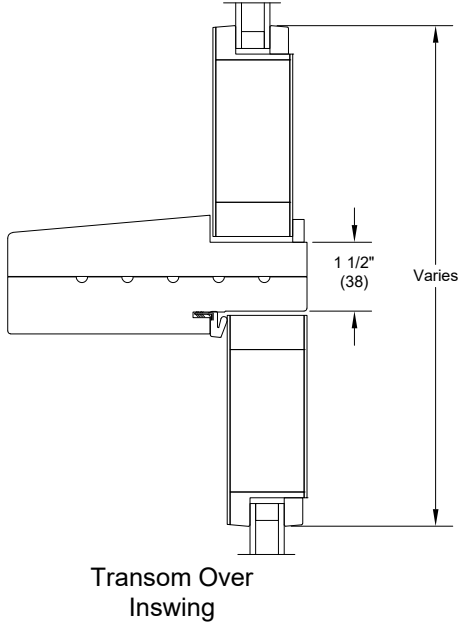
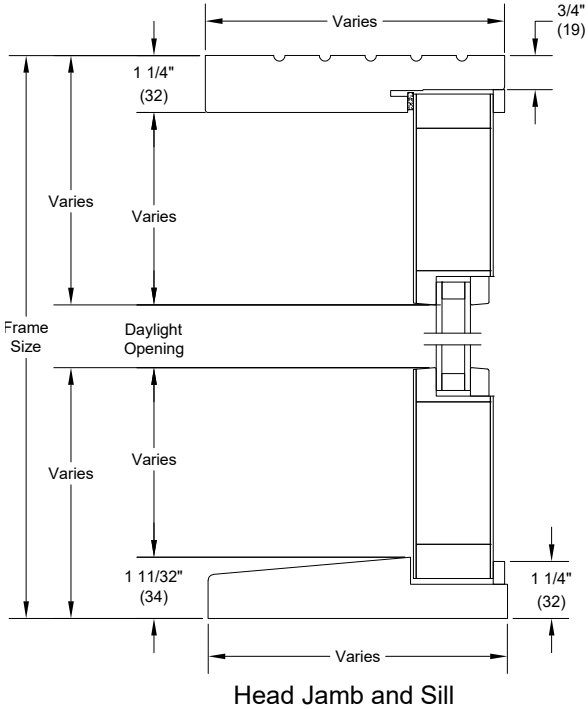

Section Details – Direct Set Transom

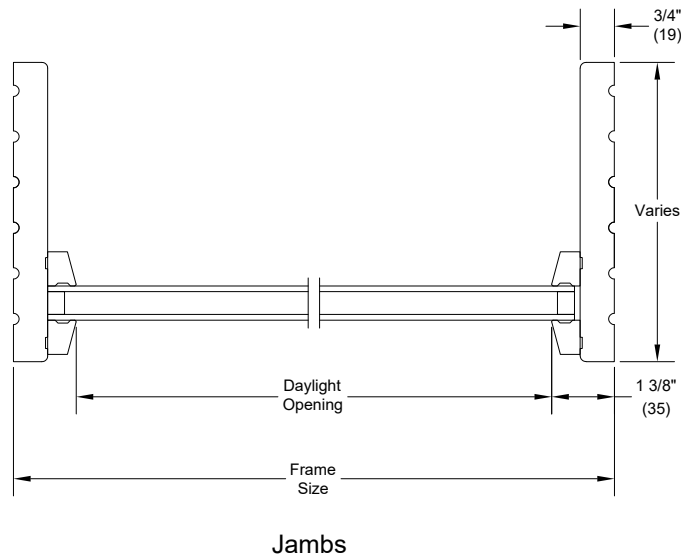
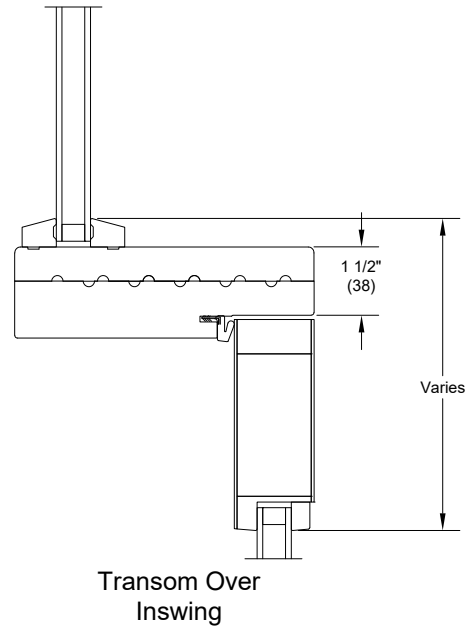
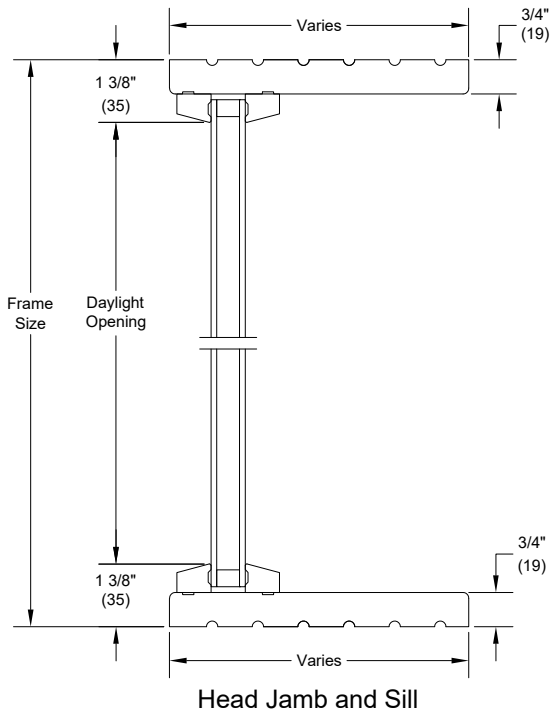

Section Details – Vertical Mulling Options

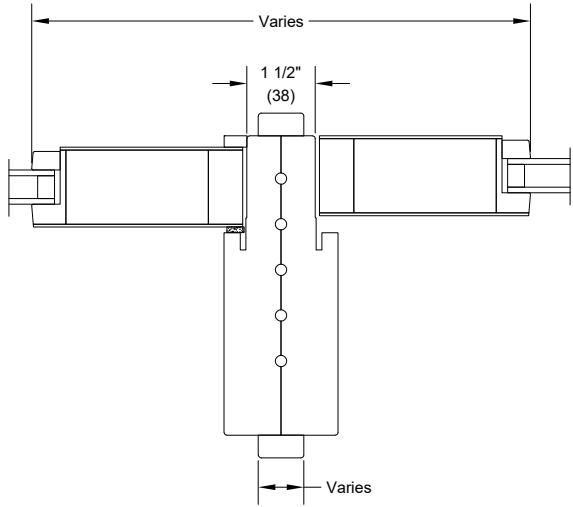

Direct Mull

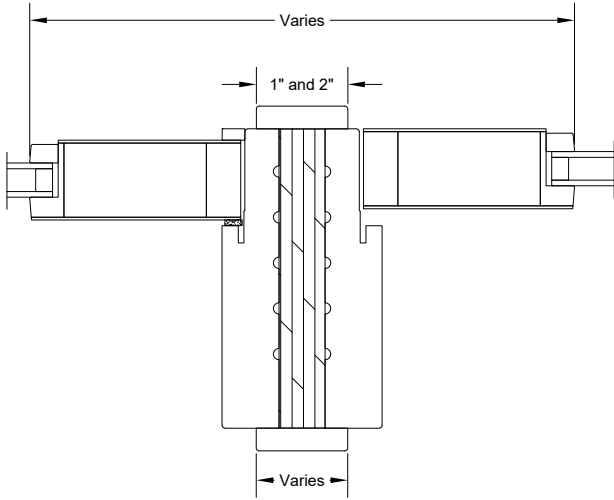

Reinforced Mull
1" LVL Option and 2" LVL Option

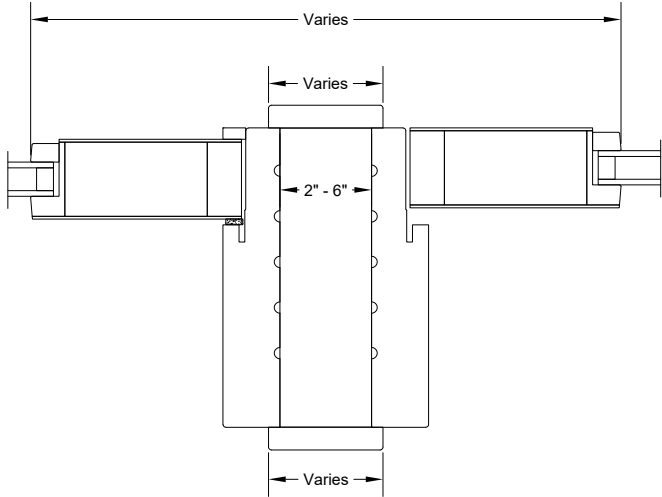

Spread Mull
2" - 6"

Section Details – Horizontal Mulling Options

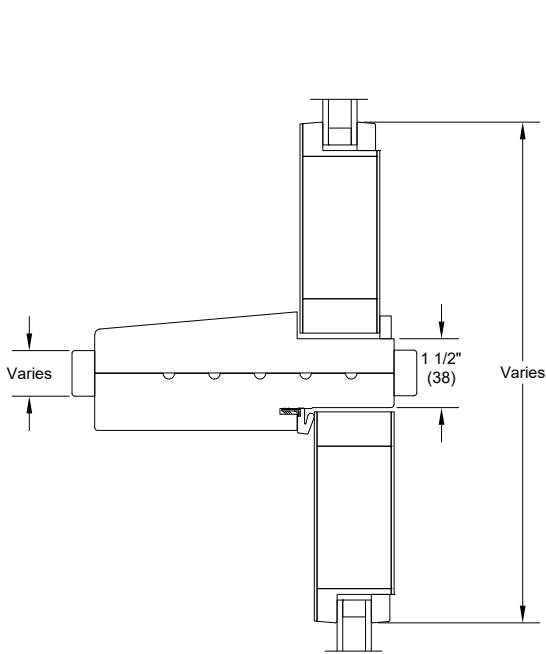

Direct Mull

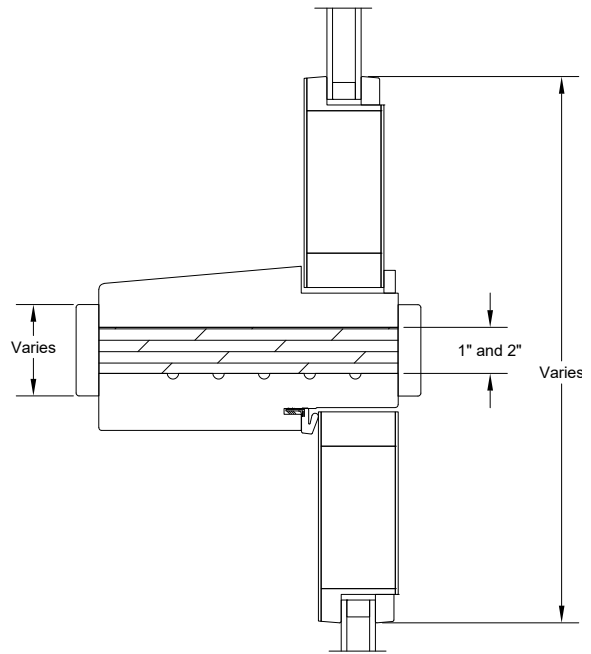

Reinforced Mull
1" LVL Option and 2" LVL Option

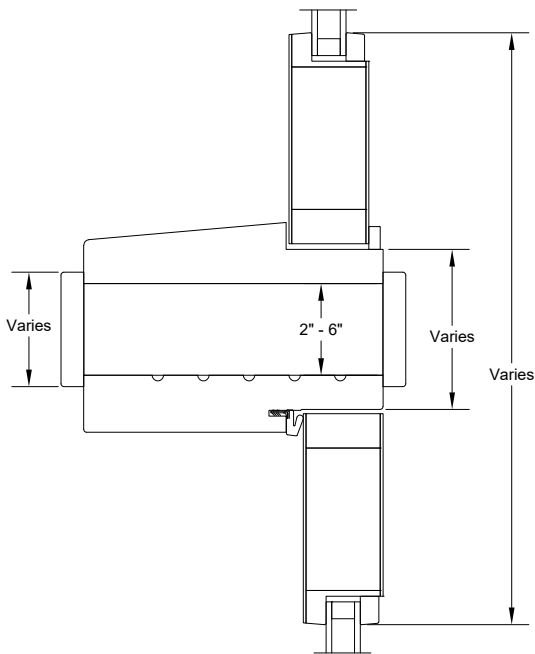

Reinforced Mull

Sticking Options – 1-3/4" Door

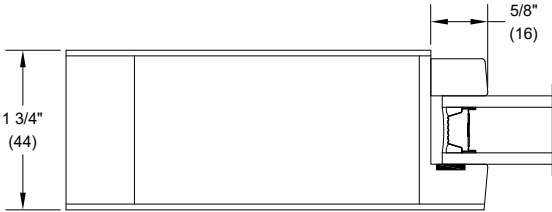

Square Stick (SS) Sticking

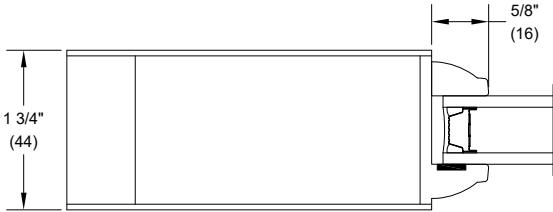

Quarter Bead (QB) Sticking

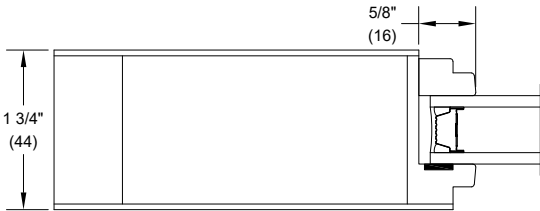

One Step (OS) Sticking

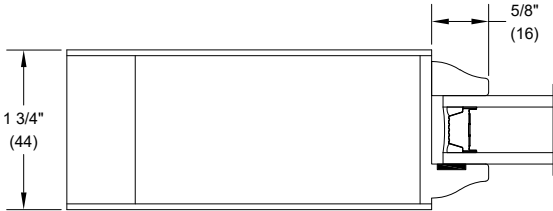

Roman Ogee (OG) Sticking

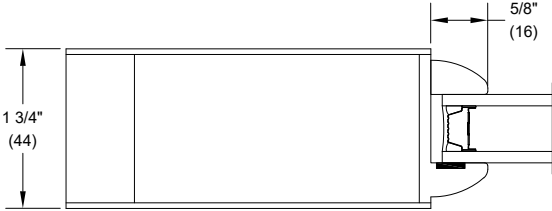

Quarter Round (QR) Sticking

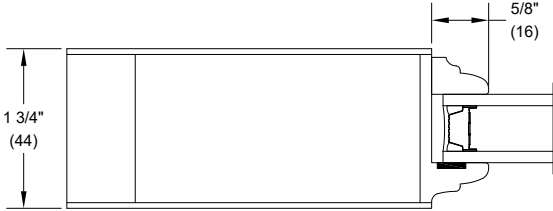

Cove and Bead (CB) Sticking

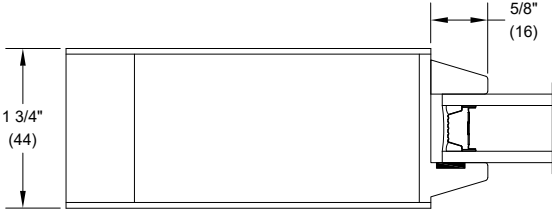

Bevel (BV) Sticking

Sticking Options – 2-1/4" Door

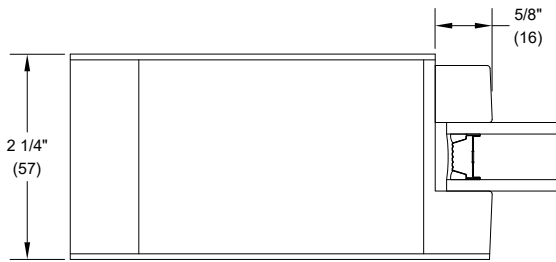

Square Stick (SS) Sticking

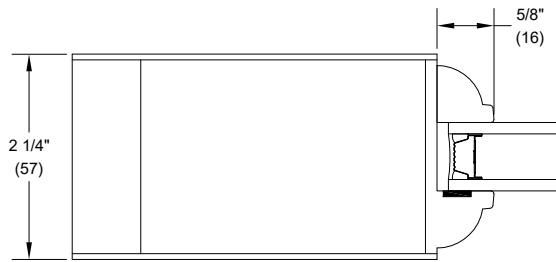

Quarter Bead (QB) Sticking

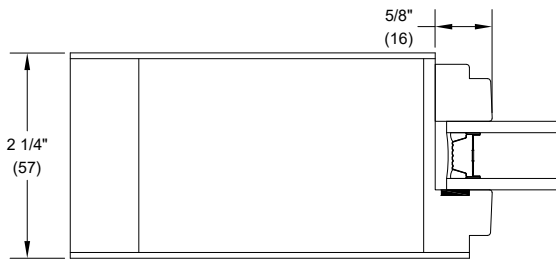

One Step (OS) Sticking

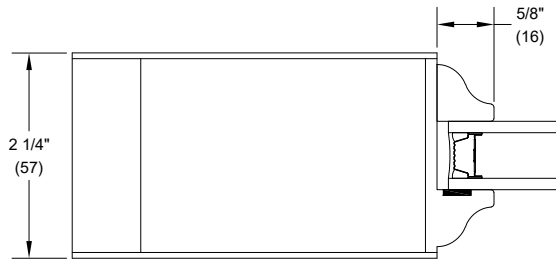

Roman Ogee (OG) Sticking

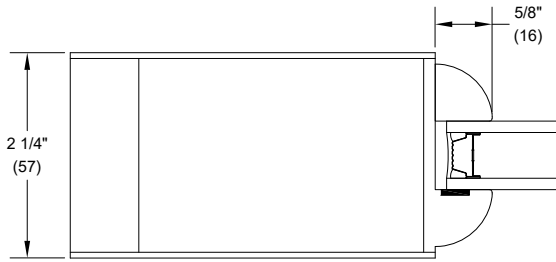

Quarter Round (QR) Sticking

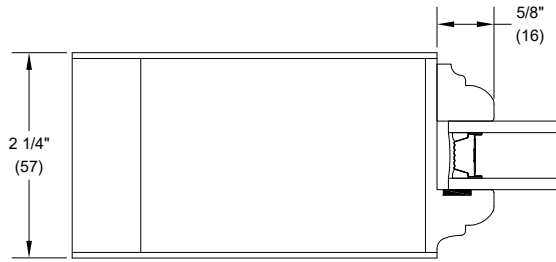

Cove and Bead (CB) Sticking

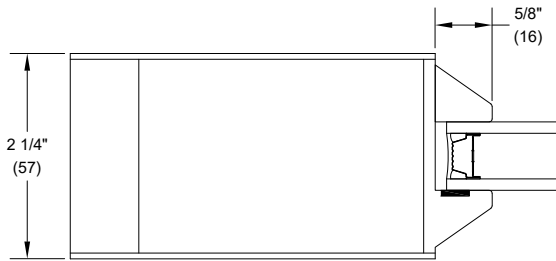

Bevel (BV) Sticking

Panel Options – 1-3/4" Door

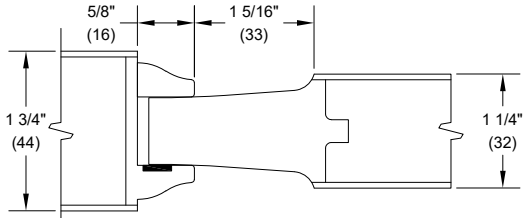

A - Raised

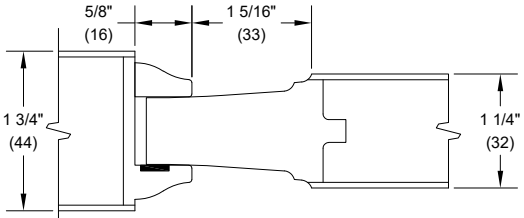

D - Double Hip

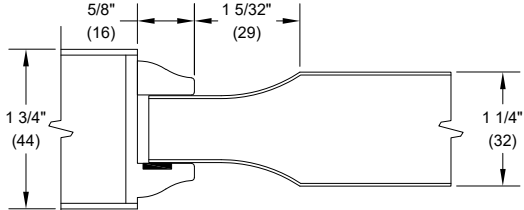

B - Scoop Bladder Pressed

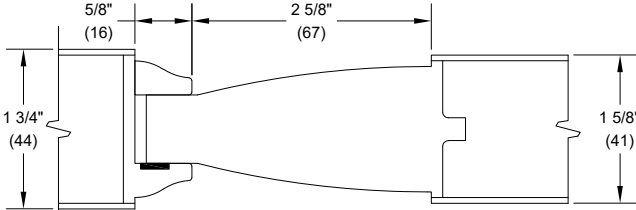

E - Senior Raised

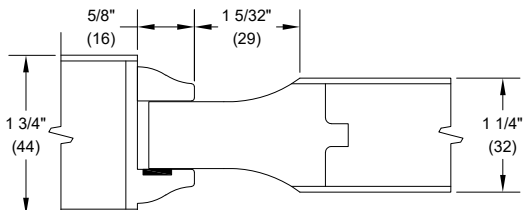

B - Scoop Rim Raised

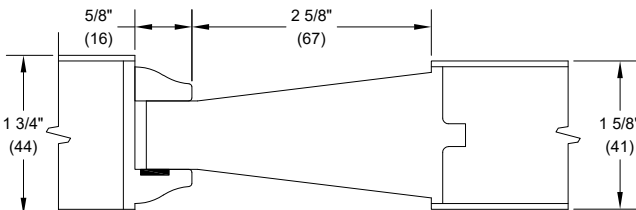

F - Senior Bevel

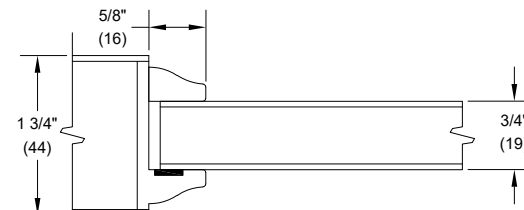

C - Flat

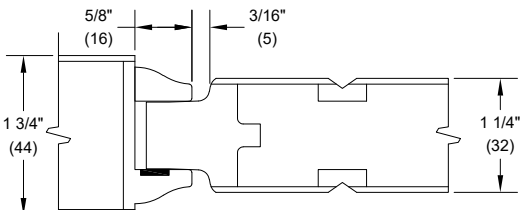

VG - V Groove

Panel Options – 2-1/4" Door

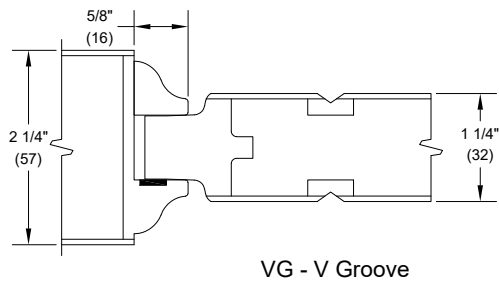
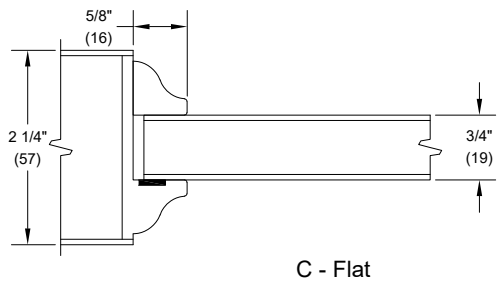
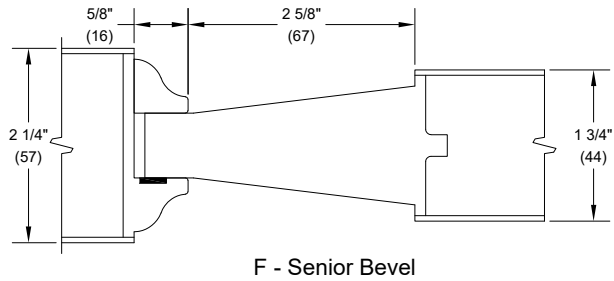
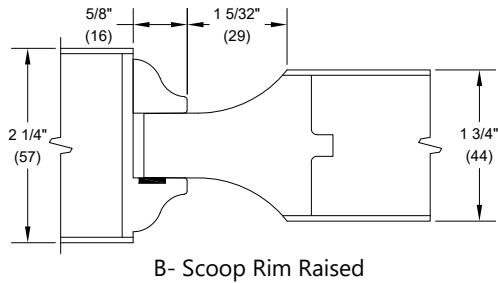
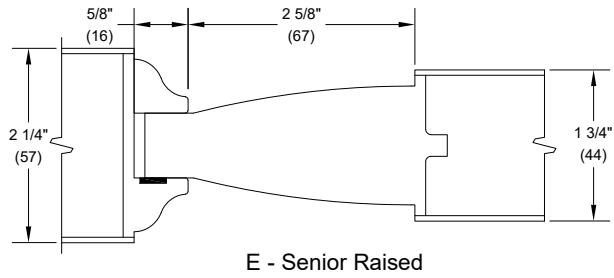
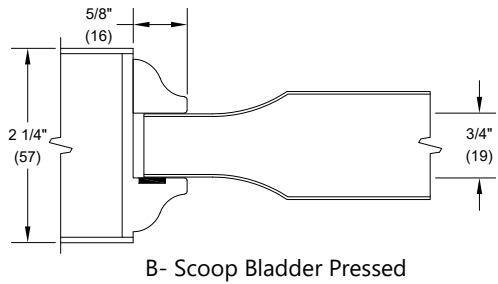
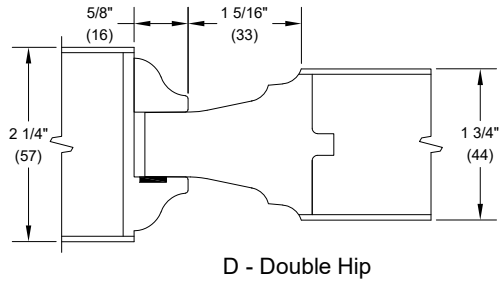
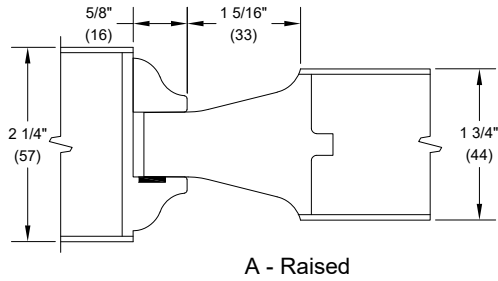

Note: All shown with Roman Ogee (OG) sticking

Simulated Divided Lites (SDL) Options – 1-3/4" Door

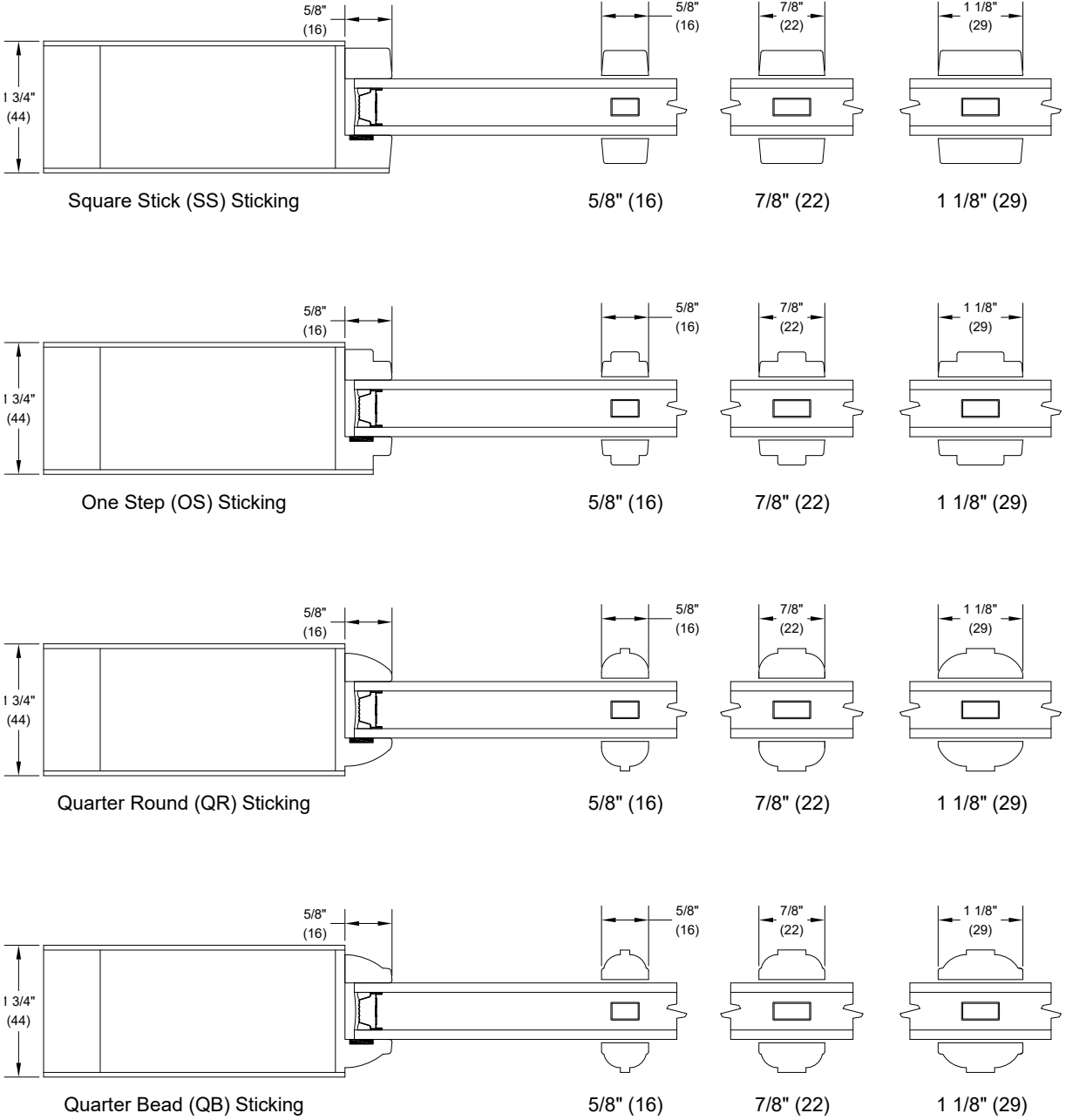

Simulated Divided Lites (SDL) Options – 1-3/4" Door

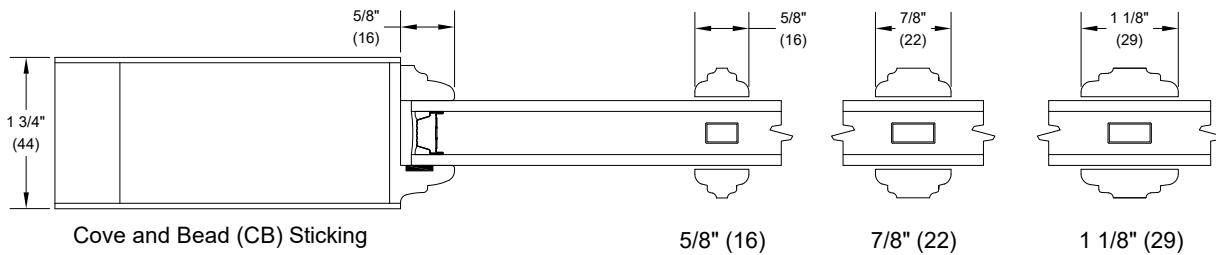
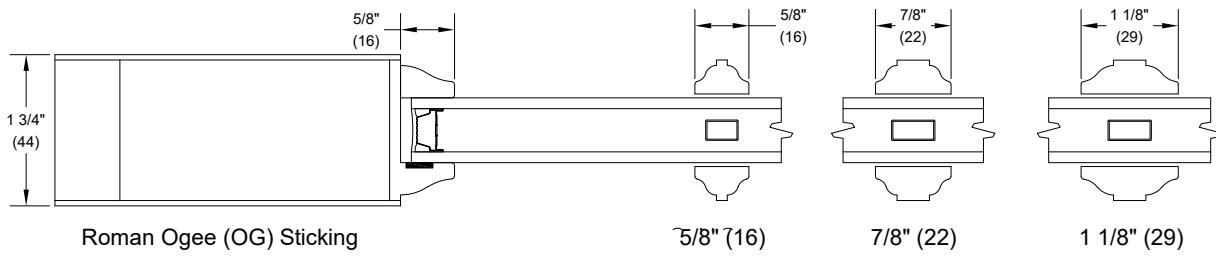
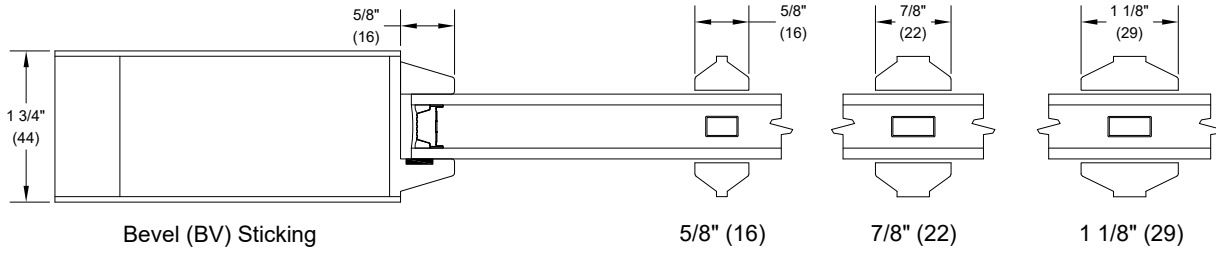

Simulated Divided Lites (SDL) Options – 2-1/4" Door

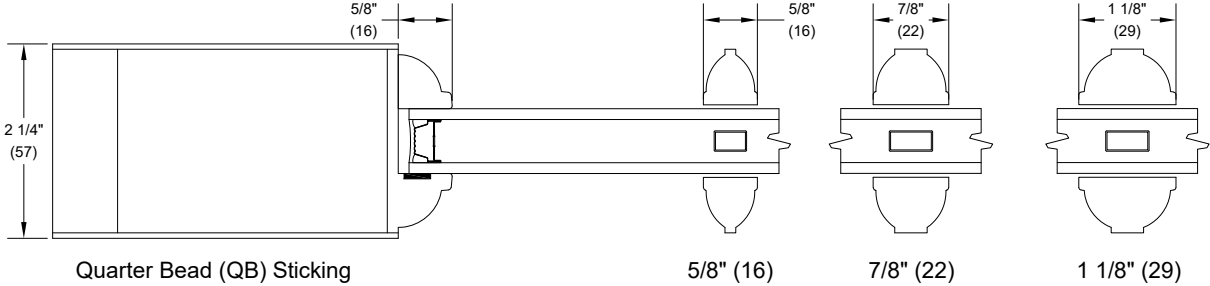
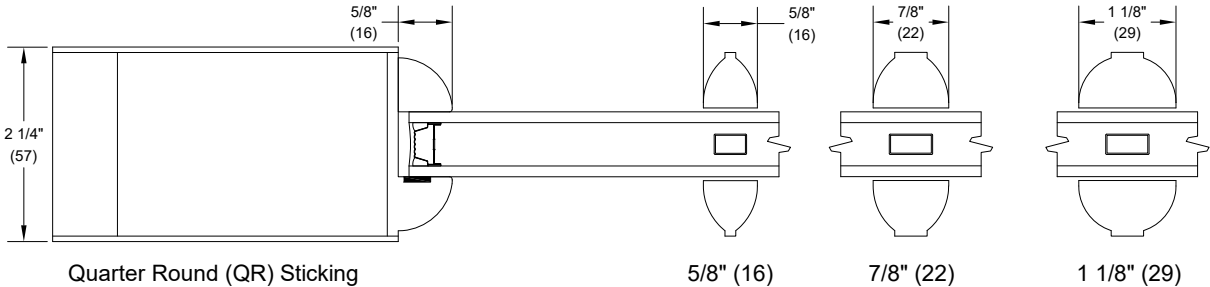
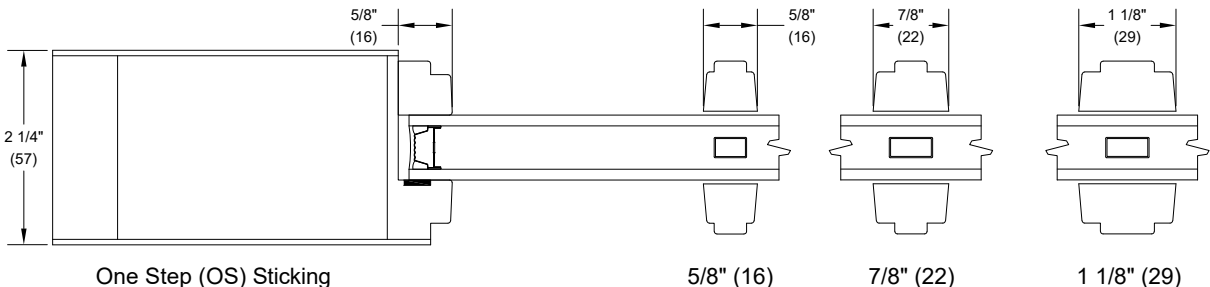
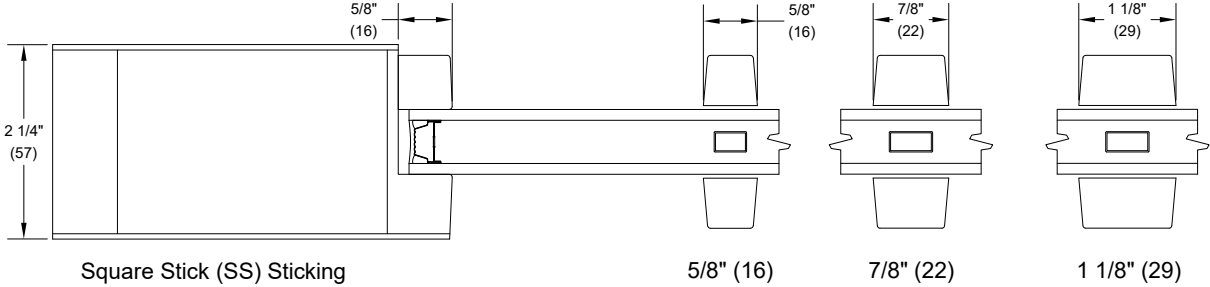

Simulated Divided Lites (SDL) Options – 2-1/4" Door

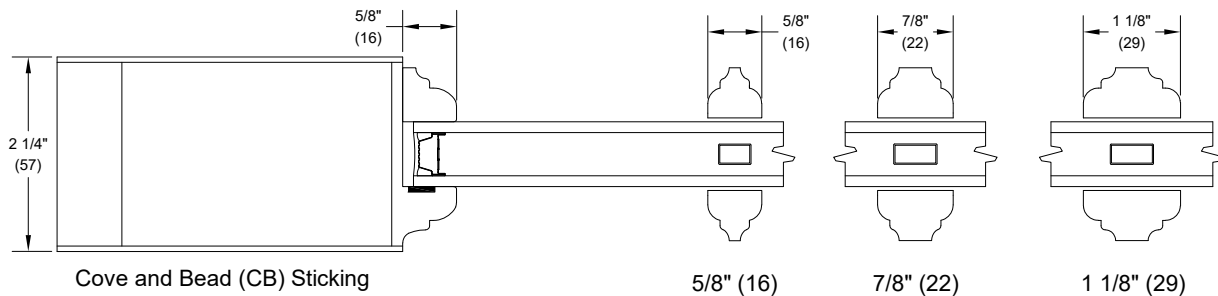
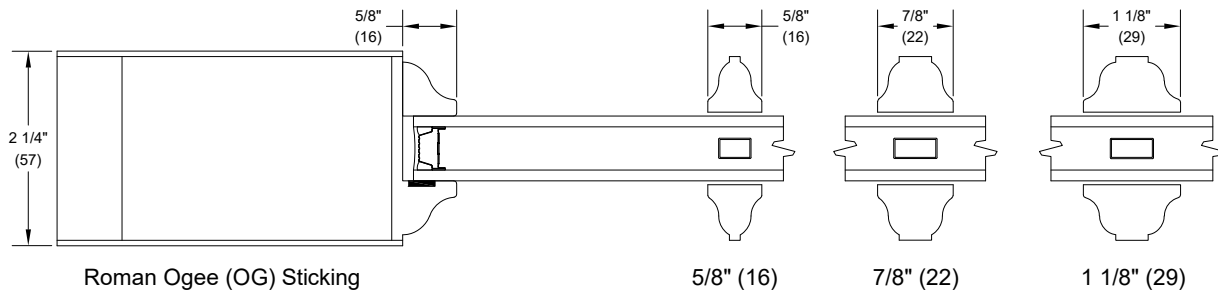
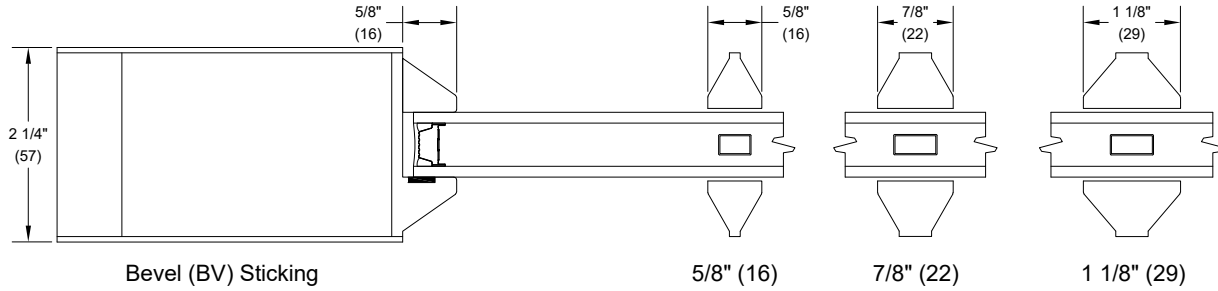

True Divided Lites (TDL) Options – 1-3/4" Door

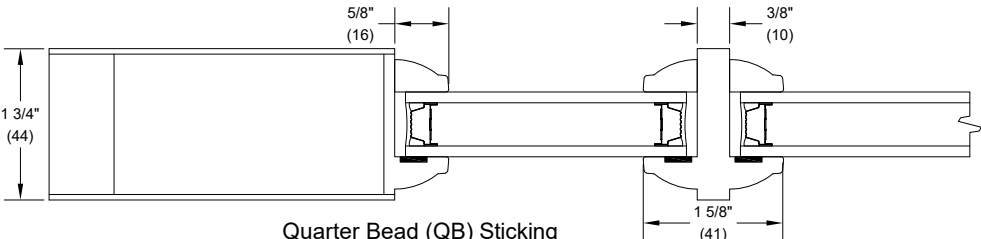
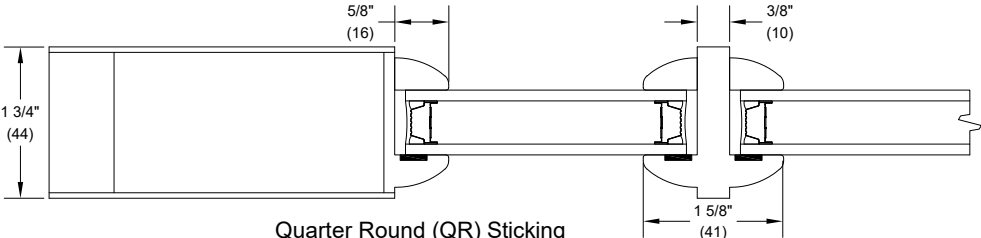
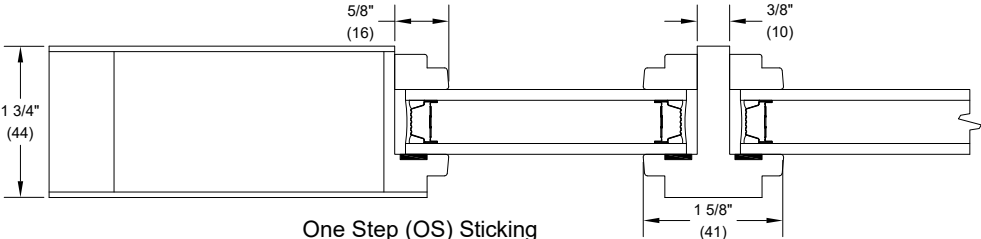
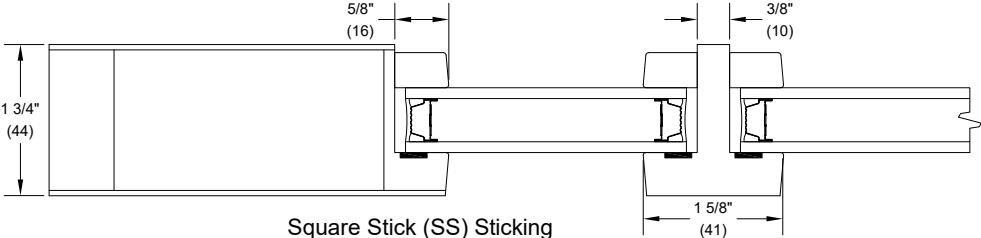

True Divided Lites (TDL) Options – 1-3/4" Door

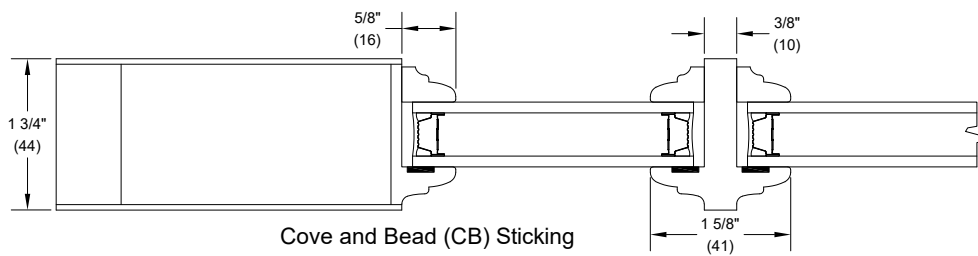
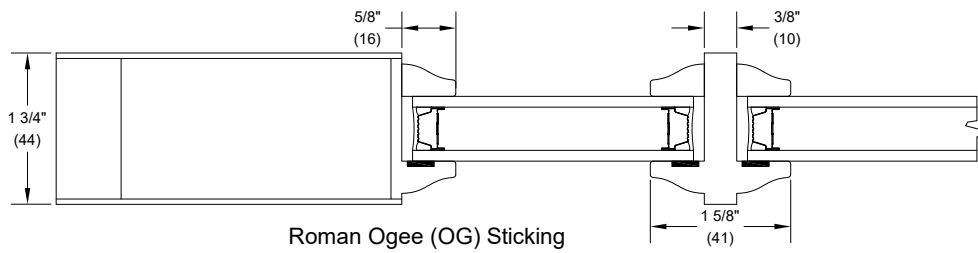
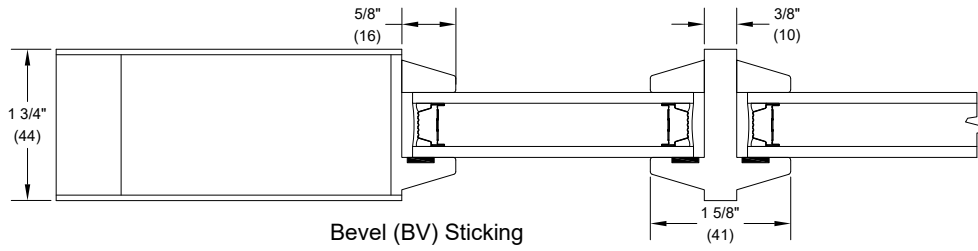

True Divided Lites (TDL) Options – 2-1/4" Door

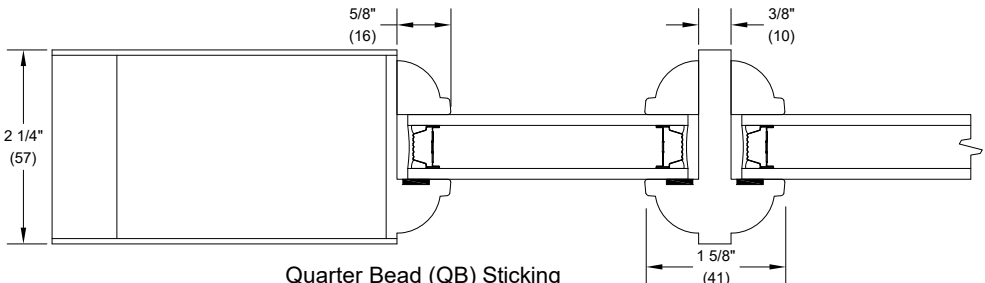
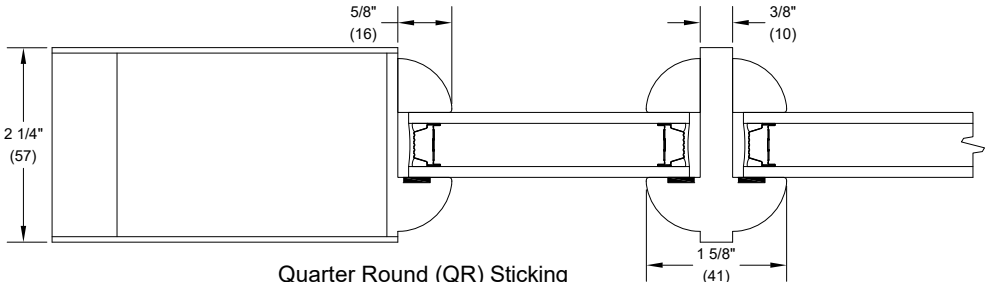
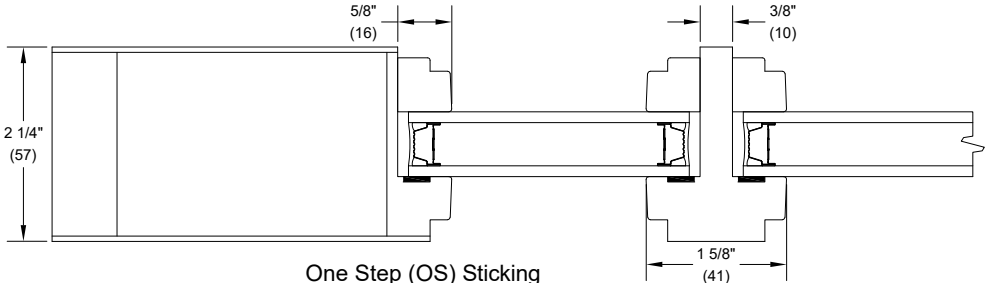
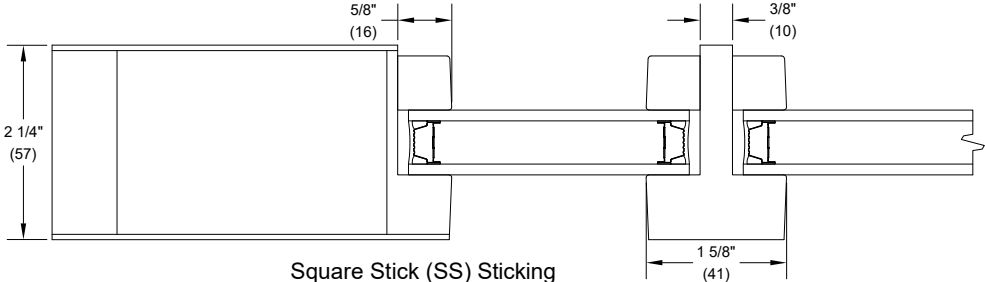

True Divided Lites (TDL) Options – 2-1/4" Door

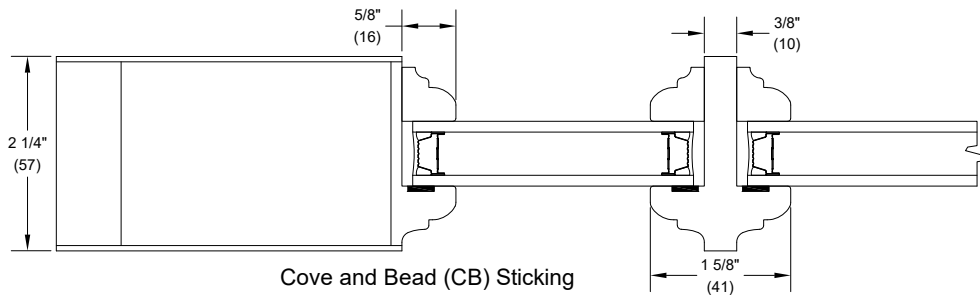
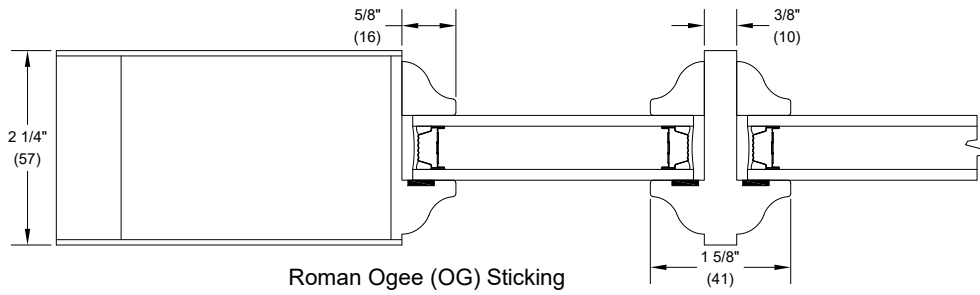
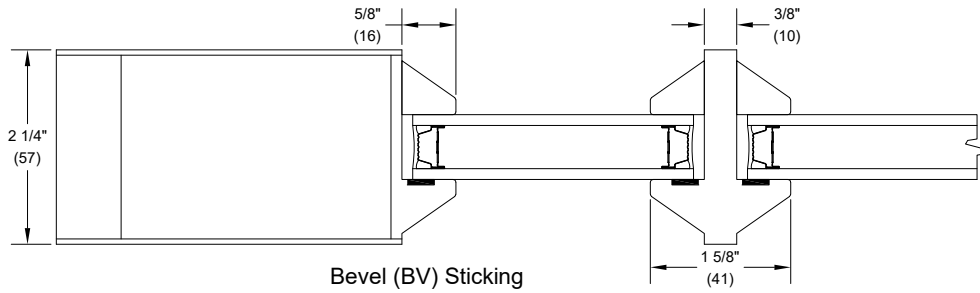

Exterior Applied Moulding Options – 1-3/4" Door

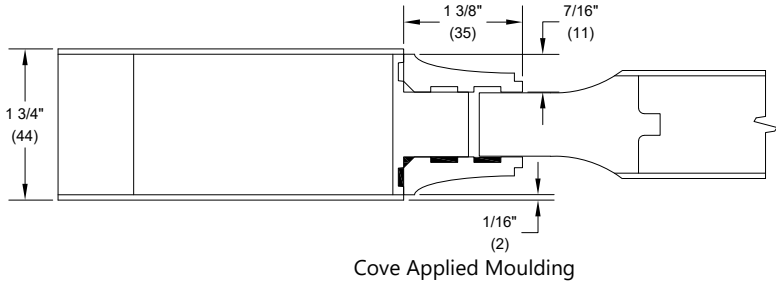

Cove Applied Moulding

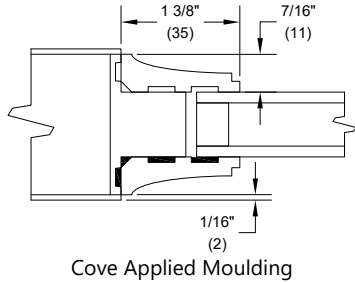

Cove Applied Moulding

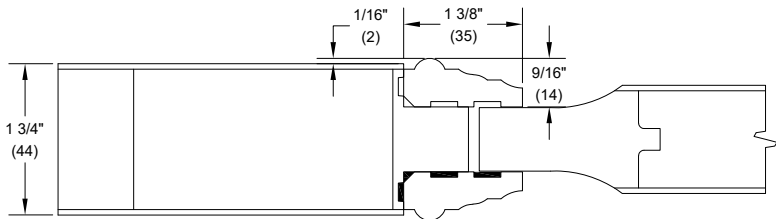

Low Profile Bolection Moulding (LP)

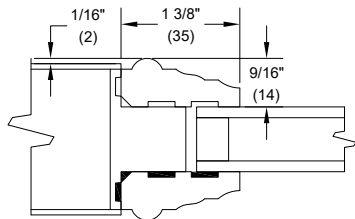

Low Profile Bolection Moulding (LP)

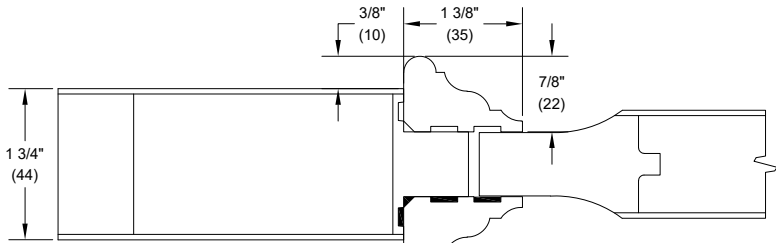

Bolection Moulding (BM)

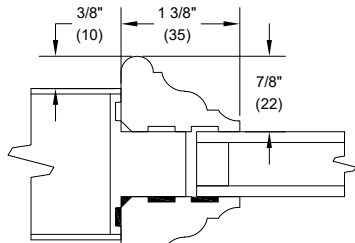

Bolection Moulding (BM)

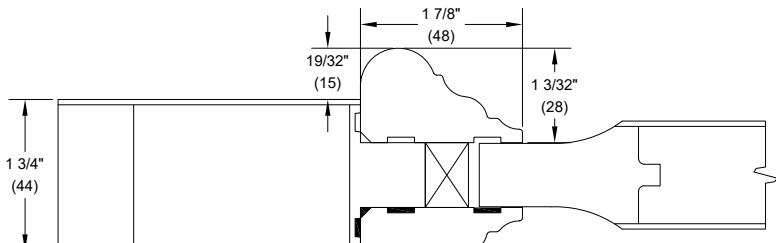

Big Bolection Moulding (BBM)

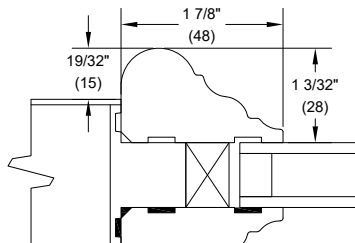

Big Bolection Moulding (BBM)

Exterior Applied Moulding Options – 2-1/4" Door

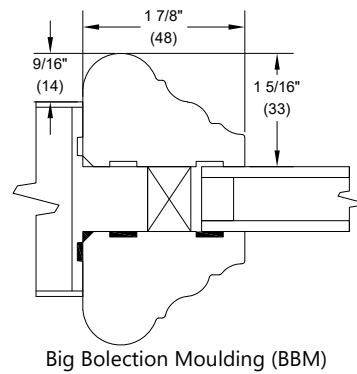
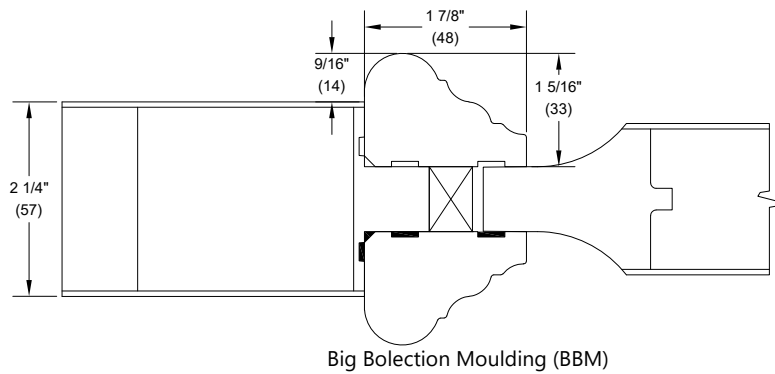
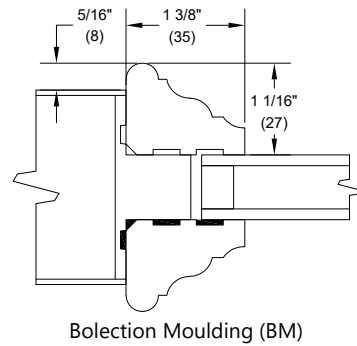
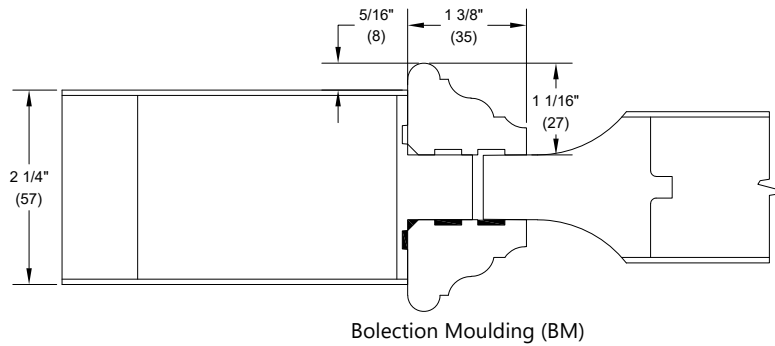
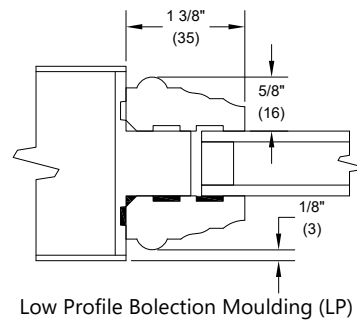
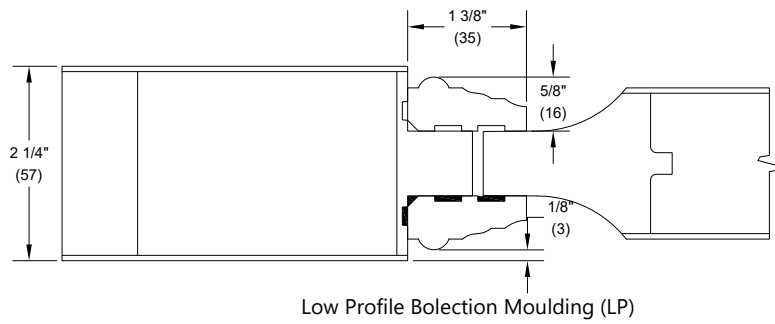
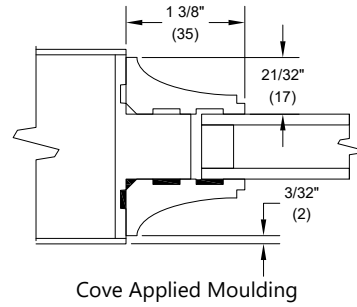
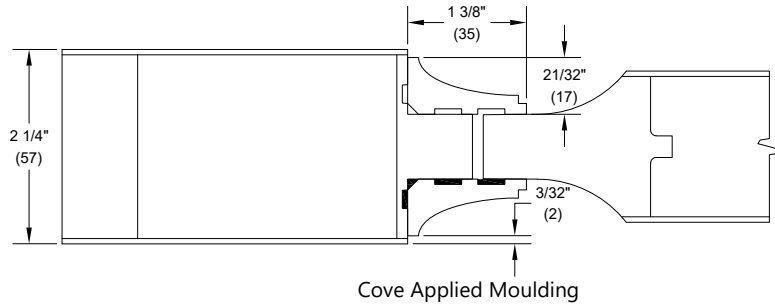

Sill Options – Oak Adjustable

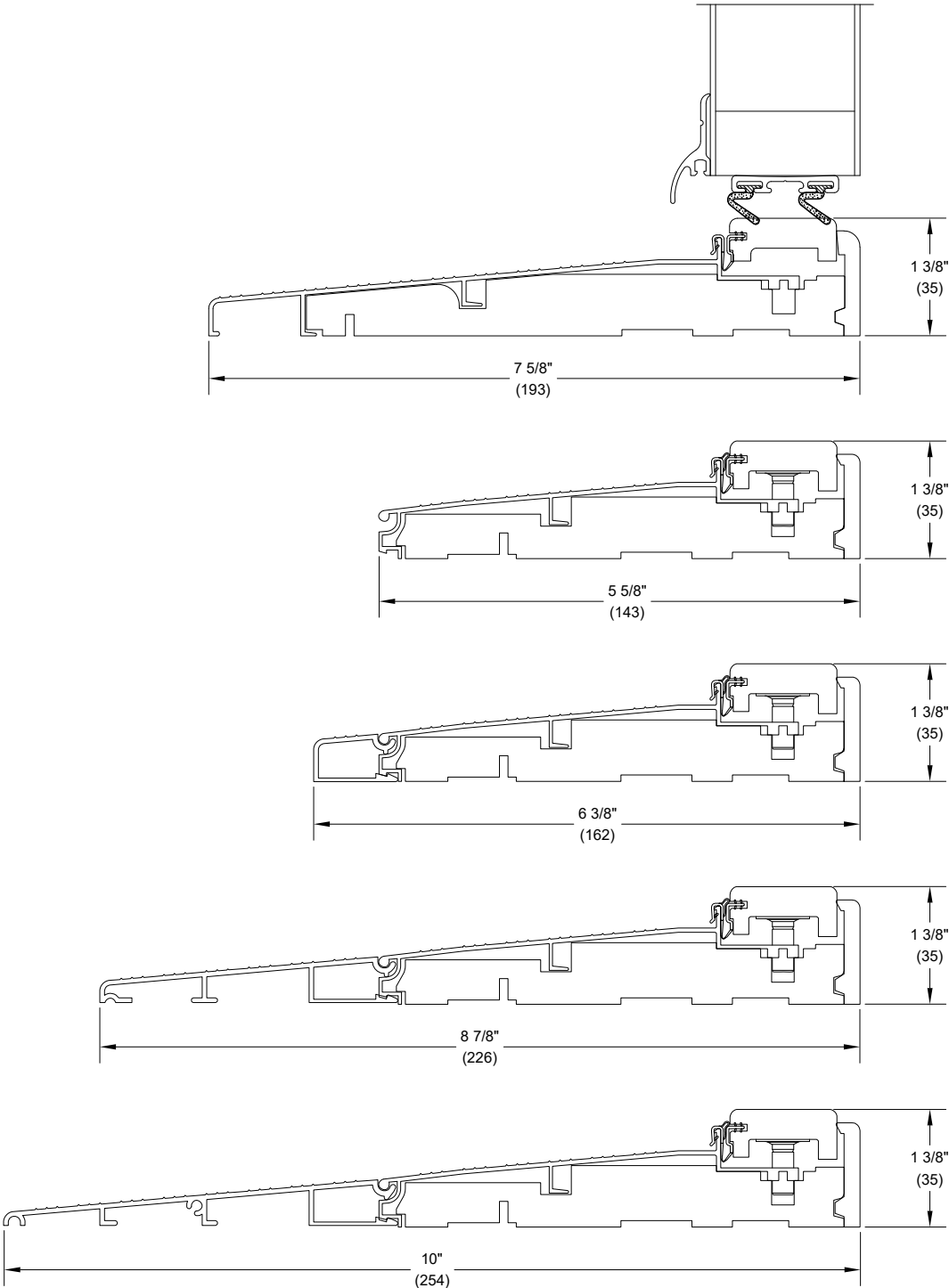

Sill Options – Solid Wood

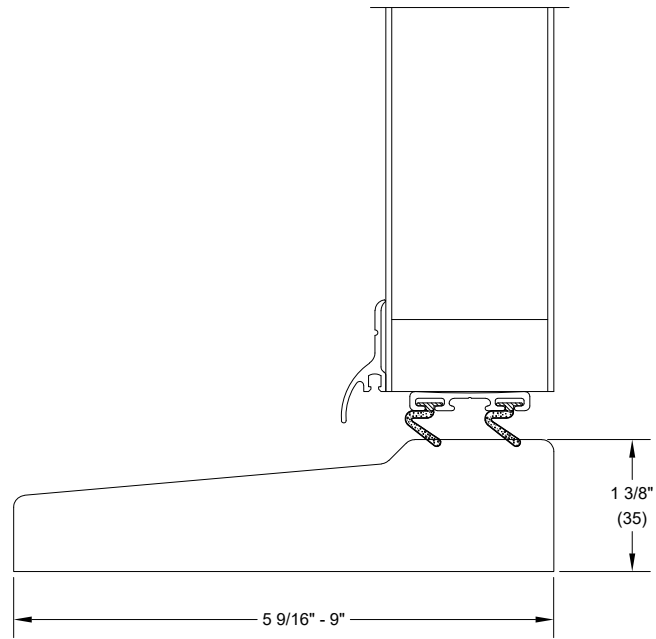

Sill Options – ADA

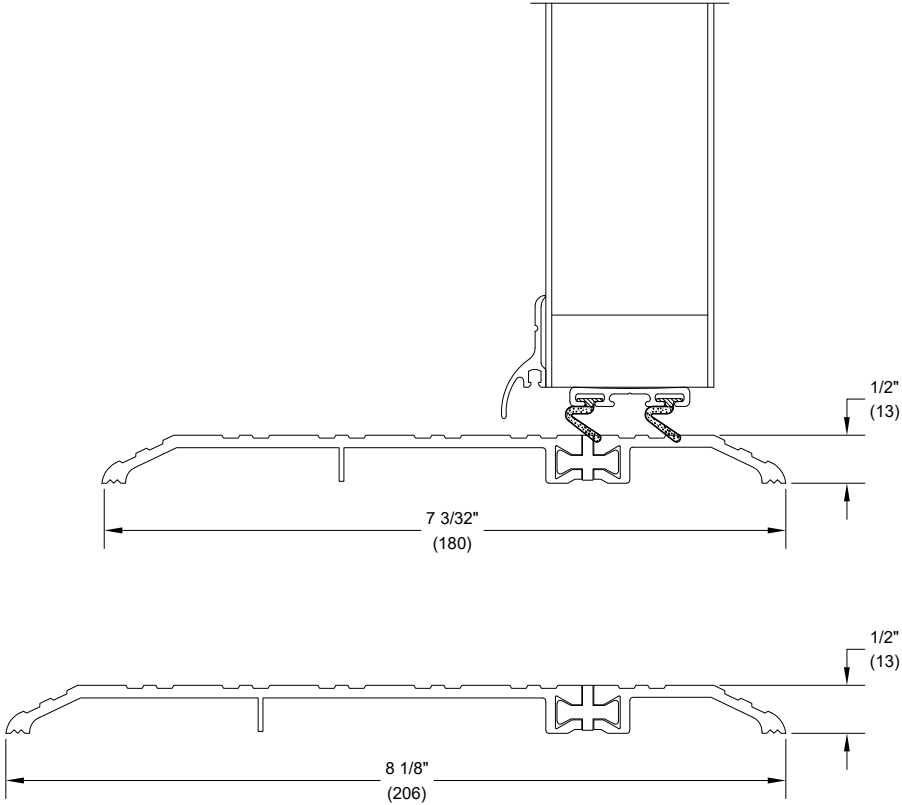

Sill Options – Hydrosill™

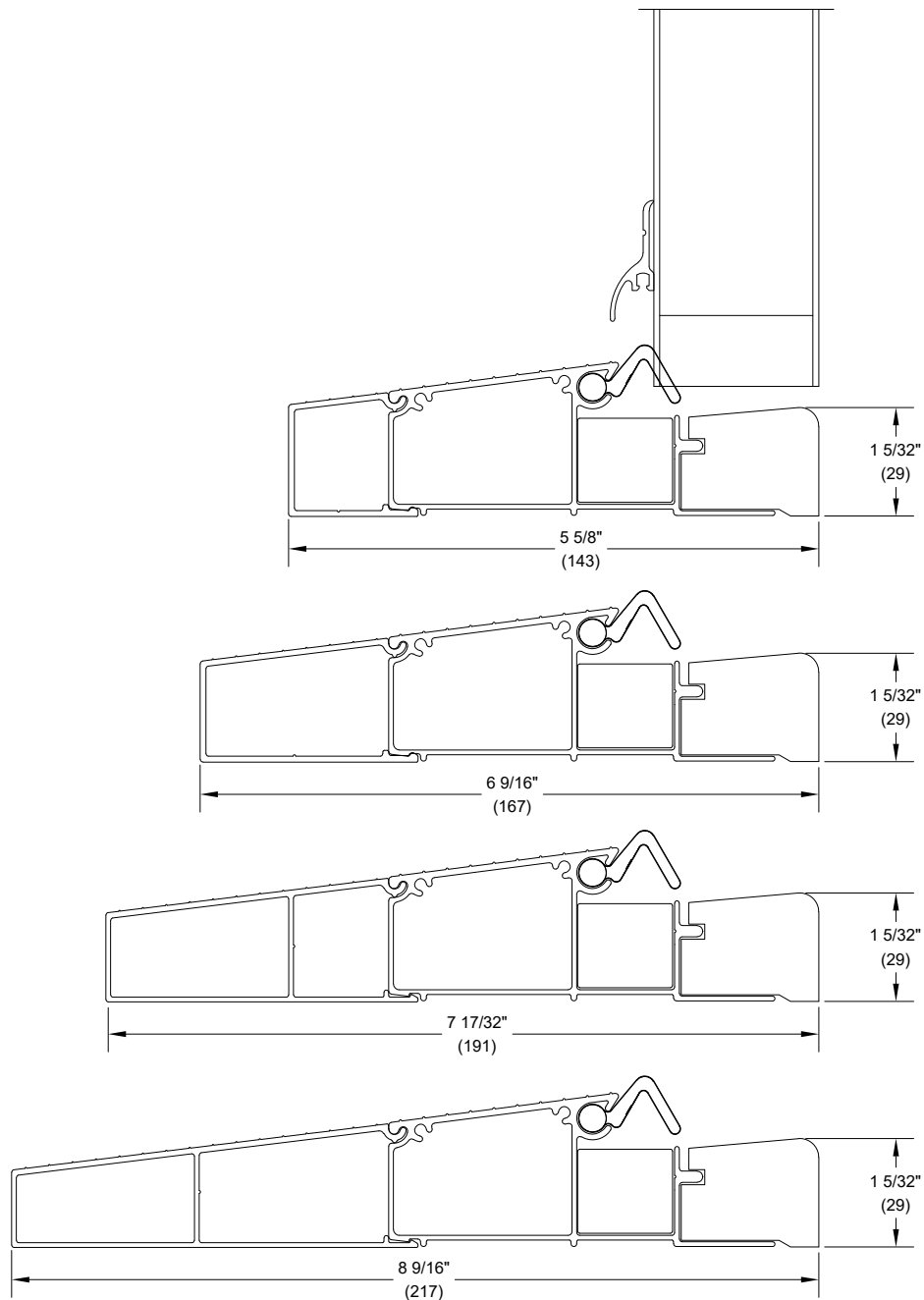

Sill Options – Solid Wood and Bronze Interlock

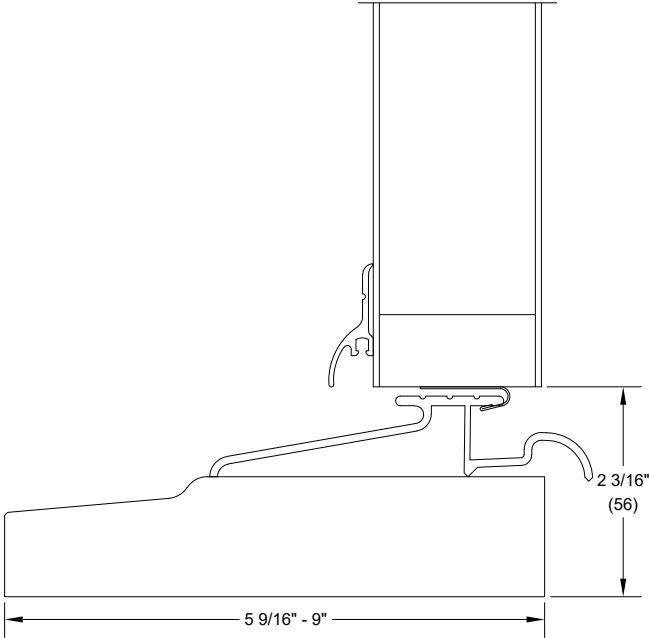

Wood Swinging Screen Options

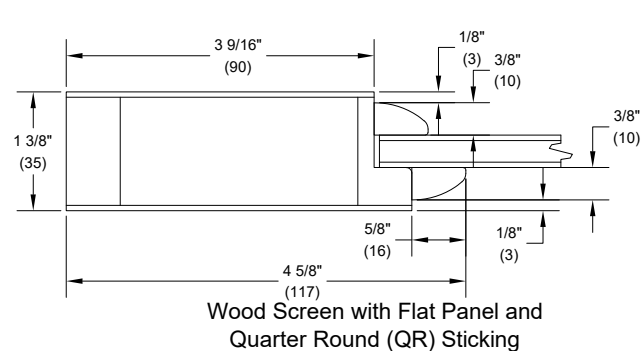
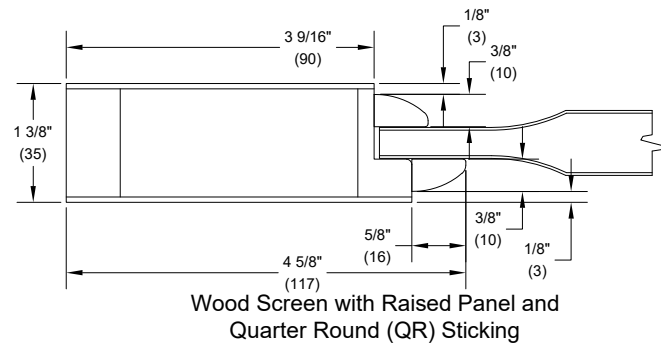
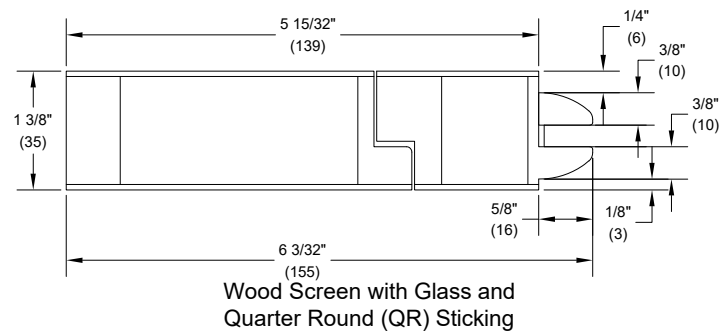
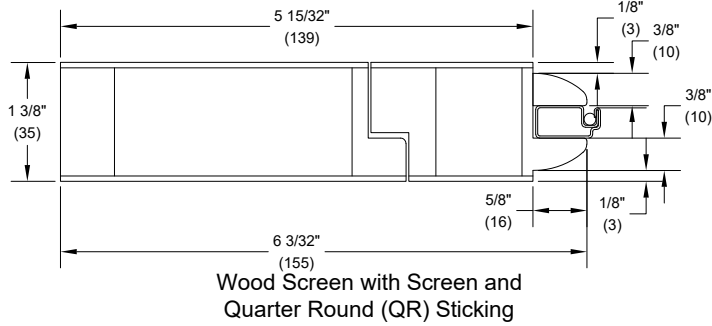

Sticking for Wood Screen with Screen and Glass

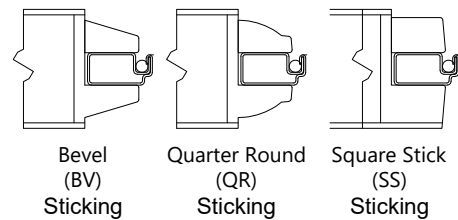
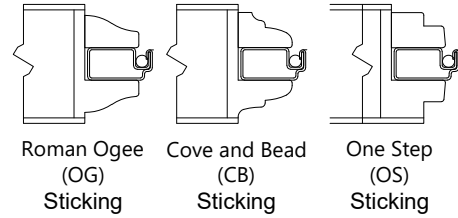

Sticking for Wood Screen with Raised Panel and Flat Panel

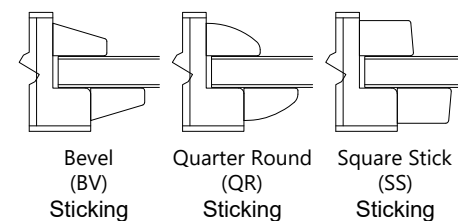
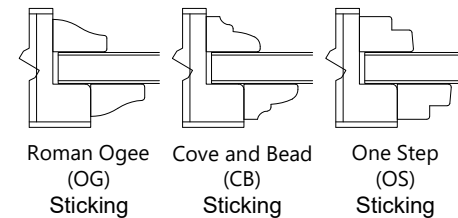

Accessories

Casings

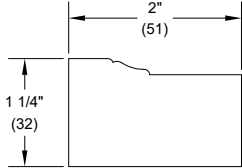

Brick Mould Casing

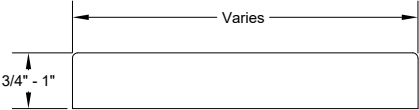

S4S Casing

Mull Cover

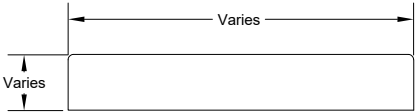

Mull Cover

Sash Stops



Square



Traditional



Metal Pemko 3452



Wood

Drip Trims

Door Bottom



Door Bottom

Dentil Shelf Options

